

12-1/2" x 20" MIDI VSR Lathe



Operator's Manual

Record the serial number and date of purchase in your manual for future reference.

The serial number can be found on the specification label on the rear of your machine.

Serial Number: _____ Date of purchase: _____

For technical support or parts questions, email techsupport@rikontools.com or call toll free at (877) 884-5167

TABLE OF CONTENTS

Specifications.....	2
Safety Instructions	3 - 6
Contents of Package	7
Getting To Know Your Machine	8
Installation	8
Assembly	8
Operation	9 - 10
Adjustments.....	11 - 13
Maintenance	14
Troubleshooting	14 - 15
Parts Diagram & Parts List	16 - 20
Electricals & Wiring Diagram	5 & 21
Accessories	21
Notes	22
Warranty	23

SPECIFICATIONS

Motor	1 HP
Motor Speed (no load).....	2,900 RPM
Volts, Phase	120 V, 1 Ph
Amps, Hertz	6 A, 60 Hz
Swing Over Bed	12-1/2" (318 mm)
Swing Over Tool Rest Base.....	9-5/8" (244 mm)
Distance Between Centers.....	20" (508 mm)
Electronic Variable Speeds	250 - 3,850 RPM
Speed Ranges (3)	250-750 / 550-1,650 / 1,300-3,850 RPM
Spindle Rotation (2)	Forward (C-Clockwise) & Reverse (Clockwise)
Spindle Nose Threading.....	1" x 8 TPI
Headstock Taper	MT-2
Tailstock Taper	MT-2
Hole Through Drive Spindle	3/8" (10 mm)
Hole Through Tailstock	3/8" (10 mm)
Tailstock Ram Travel	3-1/2" (90 mm)
Number of Indexing Positions.....	24
Tool Rest Post Diameter	1" (25.4 mm)
Overall Size (LxWxH).....	40-3/4" x 12" x 17-5/8" (1,035 x 305 x 449 mm)
Cast Base Size (LxW)	36-3/4" x 7-5/8" (195 x 933.5 mm)
Net Weight	115 lbs (52.2 kg)

NOTE: The specifications, photographs, drawings and information in this manual represent the current model when the manual was prepared. Changes and improvements may be made at any time, with no obligation on the part of Rikon Power Tools, Inc. to modify previously delivered units. Reasonable care has been taken to ensure that the information in this manual is correct, to provide you with the guidelines for the proper safety, assembly and operation of this machine.

SAFETY INSTRUCTIONS

IMPORTANT! Safety is the single most important consideration in the operation of this equipment. **The following instructions must be followed at all times.** Failure to follow all instructions listed below may result in electric shock, fire, and/or serious personal injury.

There are certain applications for which this tool was designed. We strongly recommend that this tool not be modified and/or used for any other application other than that for which it was designed. If you have any questions about its application, do not use the tool until you have contacted us and we have advised you.

SAFETY SYMBOLS



SAFETY ALERT SYMBOL: Indicates DANGER, WARNING, or CAUTION. This symbol may be used in conjunction with other symbols or pictographs.



Indicates an imminently hazardous situation, which, if not avoided, could result in death or serious injury.



Indicates a potentially hazardous situation, which, if not avoided, could result in death or serious injury.



Indicates a potentially hazardous situation, which, if not avoided, could result in minor or moderate injury.

NOTICE: Shown without Safety Alert Symbol indicates a situation that may result in property damage.

GENERAL SAFETY

KNOW YOUR POWER TOOL. Read the owner's manual carefully. Learn the tool's applications, work capabilities, and its specific potential hazards.

BEFORE USING YOUR MACHINE

To avoid serious injury and damage to the tool, read and follow all of the Safety and Operating Instructions before operating the machine.

1. Some dust created by using power tools contains chemicals known to the State of California to cause cancer, birth defects, or other reproductive harm.

Some examples of these chemicals are:

- Lead from lead-based paints.
- Crystalline silica from bricks, cement, and other masonry products.
- Arsenic and chromium from chemically treated lumber.

Your risk from these exposures varies, depending on how often you do this type of work. To reduce your exposure to these chemicals: work in a well ventilated area and work with approved safety equipment, such as those dust masks that are specially designed to filter out microscopic particles.

2. **READ** the entire Owner's Manual. **LEARN** how to use the tool for its intended applications.

3. **GROUND ALL TOOLS.** If the tool is supplied with a 3 prong plug, it must be plugged into a 3-contact electrical receptacle. The 3rd prong is used to ground the tool and provide protection against accidental electric shock. **DO NOT** remove the 3rd prong. See Grounding Instructions on the following pages.

4. **AVOID A DANGEROUS WORKING ENVIRONMENT.** **DO NOT** use electrical tools in a damp environment or expose them to rain.

5. **DO NOT** use electrical tools in the presence of flammable liquids or gasses.

6. **ALWAYS** keep the work area clean, well lit, and organized. **DO NOT** work in an environment with floor surfaces that are slippery from debris, grease, and wax.

7. **KEEP VISITORS AND CHILDREN AWAY. DO NOT** permit people to be in the immediate work area, especially when the electrical tool is operating.

8. **DO NOT FORCE THE TOOL** to perform an operation for which it was not designed. It will do a safer and higher quality job by only performing operations for which the tool was intended.

9. **WEAR PROPER CLOTHING. DO NOT** wear loose clothing, gloves, neckties, or jewelry. These items can get caught in the machine during operations and pull the operator into the moving parts. The user must wear a protective cover on their hair, if the hair is long, to prevent it from contacting any moving parts.

10. **CHILDPROOF THE WORKSHOP AREA** by removing switch keys, unplugging tools from the electrical receptacles, and using padlocks.

11. **ALWAYS UNPLUG THE TOOL FROM THE ELECTRICAL RECEPTACLE** when making adjustments, changing parts or performing any maintenance.

SAFETY INSTRUCTIONS

12. KEEP PROTECTIVE GUARDS IN PLACE AND IN WORKING ORDER.

13. AVOID ACCIDENTAL STARTING. Make sure that the power switch is in the “OFF” position before plugging in the power cord to the electrical receptacle.

14. REMOVE ALL MAINTENANCE TOOLS from the immediate area prior to turning “ON” the machine.

15. USE ONLY RECOMMENDED ACCESSORIES. Use of incorrect or improper accessories could cause serious injury to the operator and cause damage to the tool. If in doubt, check the instruction manual that comes with that particular accessory.

16. NEVER LEAVE A RUNNING TOOL UNATTENDED. Turn the power switch to the “OFF” position. **DO NOT** leave the tool until it has come to a complete stop.

17. DO NOT STAND ON A TOOL. Serious injury could result if the tool tips over, or you accidentally contact the tool.

18. DO NOT store anything above or near the tool where anyone might try to stand on the tool to reach it.

19. MAINTAIN YOUR BALANCE. DO NOT extend yourself over the tool. Wear oil resistant rubber soled shoes. Keep floor clear of debris, grease, and wax.

20. MAINTAIN TOOLS WITH CARE. Always keep tools clean and in good working order. Keep all blades and tool bits sharp, dress grinding wheels and change other abrasive accessories when worn.

21. EACH AND EVERY TIME, CHECK FOR DAMAGED PARTS PRIOR TO USING THE TOOL. Carefully check all guards to see that they operate properly, are not damaged, and perform their intended functions. Check for alignment, binding or breaking of moving parts. A guard or other part that is damaged should be immediately repaired or replaced.

22. DO NOT OPERATE TOOL WHILE TIRED, OR UNDER THE INFLUENCE OF DRUGS, MEDICATION OR ALCOHOL.

23. SECURE ALL WORK. Use clamps or jigs to secure the workpiece. This is safer than attempting to hold the workpiece with your hands.

24. STAY ALERT, WATCH WHAT YOU ARE DOING, AND USE COMMON SENSE WHEN OPERATING A POWER TOOL.

A moment of inattention while operating power tools may result in serious personal injury.

25. ALWAYS WEAR A DUST MASK TO PREVENT INHALING DANGEROUS DUST OR AIRBORNE PARTICLES, including wood dust, crystalline silica dust and asbestos dust. Direct particles away from face and body. Always operate tool in well ventilated area and provide for proper dust removal. Use dust collection system wherever possible. Exposure to the dust may cause serious and permanent respiratory or other injury, including silicosis (a serious lung disease), cancer, and death. Avoid breathing the dust, and avoid prolonged contact with dust. Allowing dust to get into your mouth or eyes, or lay on your skin may promote absorption of harmful material. Always use properly fitting NIOSH/OSHA approved respiratory protection appropriate for the dust exposure, and wash exposed areas with soap and water.

26. USE A PROPER EXTENSION CORD IN GOOD CONDITION. When using an extension cord, be sure to use one heavy enough to carry the current your product will draw. The table on the following page shows the correct size to use depending on cord length and nameplate amperage rating. If in doubt, use the next heavier gauge. The smaller the gauge number, the larger diameter of the extension cord. If in doubt of the proper size of an extension cord, use a shorter and thicker cord. An undersized cord will cause a drop in line voltage resulting in a loss of power and overheating.
USE ONLY A 3-WIRE EXTENSION CORD THAT HAS A 3-PRONG GROUNDING PLUG AND A 3-POLE RECEPTACLE THAT ACCEPTS THE TOOL’S PLUG.

27. ADDITIONAL INFORMATION regarding the safe and proper operation of this product is available from:

- Power Tool Institute
1300 Summer Avenue
Cleveland, OH 44115-2851
www.powertoolinstitute.org
- National Safety Council
1121 Spring Lake Drive
Itasca, IL 60143-3201
www.nsc.org
- American National Standards Institute
25 West 43rd Street, 4th Floor
New York, NY 10036
www.ansi.org
- ANSI 01.1 Safety Requirements for Woodworking Machines and the U.S. Department of Labor regulations
www.osha.gov

28. SAVE THESE INSTRUCTIONS. Refer to them frequently and use them to instruct others.

SAFETY INSTRUCTIONS

ELECTRICAL SAFETY

⚠ WARNING: THIS TOOL MUST BE GROUNDED WHILE IN USE TO PROTECT THE OPERATOR FROM ELECTRIC SHOCK.

IN THE EVENT OF A MALFUNCTION OR BREAKDOWN, grounding provides the path of least resistance for electric current and reduces the risk of electric shock. This tool is equipped with an electric cord that has an equipment grounding conductor and requires a grounding plug (not included). The plug **MUST** be plugged into a matching electrical receptacle that is properly installed and grounded in accordance with **ALL** local codes and ordinances.

DO NOT MODIFY ANY PLUG. If it will not fit the electrical receptacle, have the proper electrical receptacle installed by a qualified electrician.

IMPROPER ELECTRICAL CONNECTION of the equipment grounding conductor can result in risk of electric shock. The conductor with the green insulation (with or without yellow stripes) is the equipment grounding conductor. **DO NOT** connect the equipment grounding conductor to a live terminal if repair or replacement of the electric cord or plug is necessary.

CHECK with a qualified electrician or service personnel if you do not completely understand the grounding instructions, or if you are not sure the tool is properly grounded when installing or replacing a plug.

USE ONLY A 3-WIRE EXTENSION CORD THAT HAS THE PROPER TYPE OF A 3-PRONG GROUNDING PLUG THAT MATCHES THE MACHINE'S 3-PRONG PLUG AND ALSO THE 3-POLE RECEPTACLE THAT ACCEPTS THE TOOL'S PLUG. *

REPLACE A DAMAGED OR WORN CORD IMMEDIATELY.

This tool is intended for use on a circuit that has an electrical receptacle as shown in **FIGURE A**. It shows a 3-wire electrical plug and electrical receptacle that has a grounding conductor. If a properly grounded electrical receptacle is not available, an adapter as shown in **FIGURE B** can be used to temporarily connect this plug to a 2-contact ungrounded receptacle. The adapter has a rigid lug extending from it that **MUST** be connected to a permanent earth ground, such as a properly grounded receptacle box. **THIS ADAPTER IS PROHIBITED IN CANADA.**

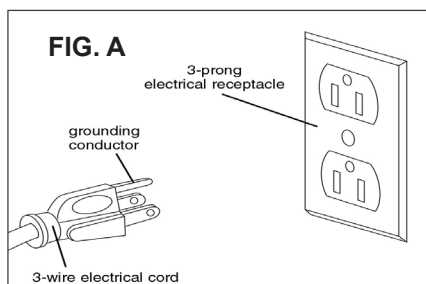

EXTENSION CORDS

⚠ WARNING: THE USE OF AN EXTENSION CORD WITH THIS MACHINE IS NOT RECOMMENDED. For best power and safety, plug the machine directly into a dedicated, grounded electrical outlet that is within the supplied cord length of the machine.

If an extension cord needs to be used, it should only be for a limited operation of the machine. The extension cord should be as short as possible in length, and have a minimum gauge size of 14AWG.

⚠ WARNING: Check extension cords before each use. If damaged replace immediately. Never use a tool with a damaged cord, since touching the damaged area could cause electrical shock, resulting in serious injury.

Use a proper extension cord. Only use cords listed by Underwriters Laboratories (UL). Other extension cords can cause a drop in line voltage, resulting in a loss of power and overheating of tool. When operating a power tool outdoors, use an outdoor extension cord marked "W-A" or "W". These cords are rated for outdoor use and reduce the risk of electric shock.

MINIMUM RECOMMENDED GAUGE FOR EXTENSION CORDS (AWG)

120 VOLT OPERATION ONLY				
	25' LONG	50' LONG	100' LONG	150' LONG
0 to 6 Amps	18 AWG	16 AWG	16 AWG	14 AWG
6 to 10 Amps	18 AWG	16 AWG	14 AWG	12 AWG
10 to 12 Amps	16 AWG	16 AWG	14 AWG	12 AWG

⚠ WARNING: Keep the extension cord clear of the working area. Position the cord so that it will not get caught on lumber, tools or other obstructions while you are working with your power tool.

* Canadian electrical codes require extension cords to be certified SJT type or better.

** The use of an adapter in Canada is not acceptable.

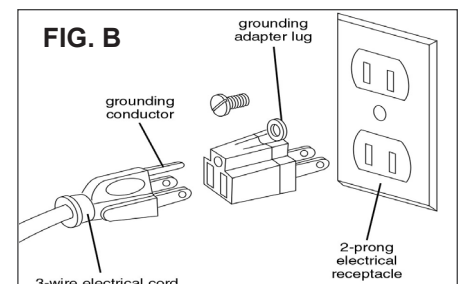

SAFETY INSTRUCTIONS

SPECIFIC SAFETY INSTRUCTIONS FOR WOOD LATHES

This machine is intended for the shaping, smoothing and finishing of natural, solid woods. The permissible workpiece dimensions must be observed (see Technical Specification). Any other use not as specified, including modification of the machine or use of parts not tested and approved by the equipment manufacturer can cause unforeseen damage.

ATTENTION: Use of this lathe still presents risks that cannot be eliminated by the manufacturer. Therefore, the user must be aware that wood working machines are dangerous if not used with care and all safety precautions are adhered to.

1. Do not operate this machine until you have read all of the following instructions.
2. Do not attempt to operate this machine until it is completely assembled.
3. Do not turn ON this machine if any pieces are damaged or missing.
4. This machine must be properly grounded.
5. If you are not familiar with the operation of the machine, obtain assistance from a qualified person.
6. Always wear eye protection and respirator.
7. Always wear a dust mask and use adequate dust collection and proper ventilation.
8. Do not wear gloves, neckties or loose clothing. Tie back long hair.
9. Disconnect the power before servicing or making adjustments.
10. Do not change speeds until the machine comes to a full stop and unplug from power source.
11. Keep fingers, clothing and hair away from rotating stock.
12. The clearance between the workpiece and the tool rest should be only about 1/8".
13. Never adjust the tool rest while the lathe is turned on.
14. Tighten all locks and clamping devices before operating.
15. Turn off and unplug the lathe after use, to prevent accidental use.
16. Use only sharp lathe tools. Dull tools can damage your work and are unsafe to use.
17. Make sure workpiece is secure and centered before operating.
18. When face plate turning, rough-cut the workpiece close to the finished shape before screwing it to the face plate.
19. Never jam tools into the workpiece or take too big of a cut.
20. Make sure there are no loose knots, nails, staples, dirt or foreign objects in the workpiece to be turned.
21. Wood should not be warped, cracked or have improperly made or cured glue joints.
22. Rotate workpiece by hand before starting power to check for clearance.
23. Start the lathe at slow speeds to check the settings, then increase the speed to your desired level for working.
24. Low speeds are best for roughing stock, and for long or large diameter workpieces.
25. If excessive vibration occurs, stop the lathe to check the workpiece settings between centers or on face plates.
26. For sanding or applying finishes, remove the tool rest from the machine. Use low speeds to avoid heat build-up.
27. Do not engage the spindle lock when the lathe is turning, and be sure to disengage the spindle lock when done working to avoid damage to the machine next time the lathe is turned on.
28. Never stop the machine by grabbing the workpiece, faceplate or hand wheel. Let the machine stop on its own.
29. The use of any accessories or attachments not recommended may cause injury to you and damage your machine.
30. Remove material or debris from the work area. Keep the floor and work area neat and clean.
31. Keep these instructions for future reference.

This owner's manual is not a teaching aid and is intended to show assembly, adjustments, and general use.

California Proposition 65 Warning



WARNING: Drilling, sawing, sanding or machining wood products can expose you to wood dust, a substance known to the State of California to cause cancer. Avoid inhaling wood dust or use a dust mask or other safeguards for personal protection. For more information go to www.P65Warnings.ca.gov/wood.

CONTENTS OF PACKAGE

CONTENTS OF PACKAGE

- A. Lathe Bed Assembly - including;
- B. Motor Assembly
- C. Headstock Assembly
- D. Tailstock Assembly
- E. Electronic Controls

NOTE: Lathe shown with Outboard Hand Wheel * on the Headstock and Tailstock Hand Wheel ** installed.
Lathe is shown on the #70-920 Stand (sold separately)

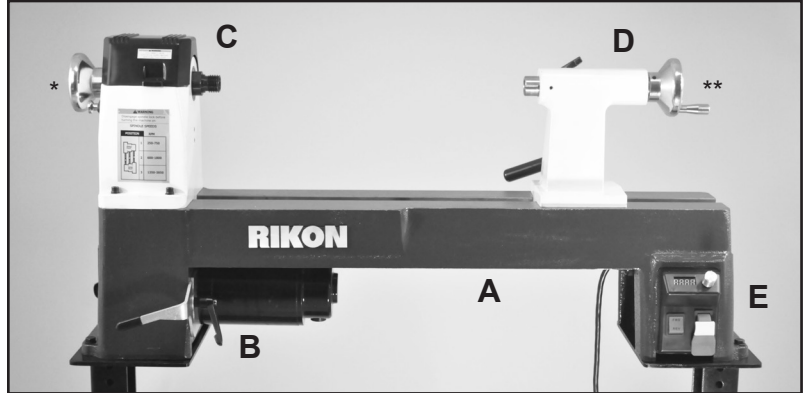

LIST OF LOOSE PARTS

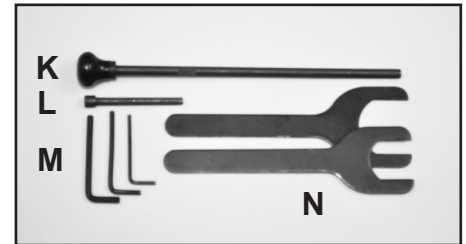
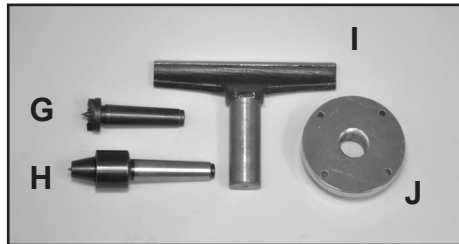
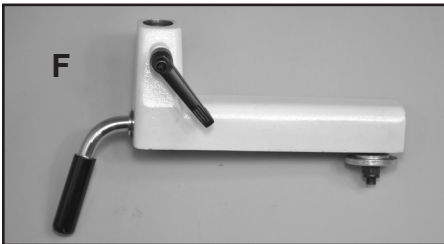

- F. Tool Rest Base
- G. Spur Center
- H. Live Center
- I. 8" Tool Rest
- J. 3" Faceplate
- K. Long Knockout Bar
- L. Short Knockout Bar
- M. Hex Wrenches (3, 4, 5 mm)
- N. Spanner Wrenches (32, 46 mm)
- O. Tool Holder, Screws & Washers (2)
- P. Outboard Hand Wheel
- Q. Tailstock Hand Wheel
- R. Manual & Warranty Card (not shown)

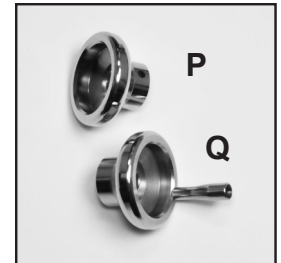
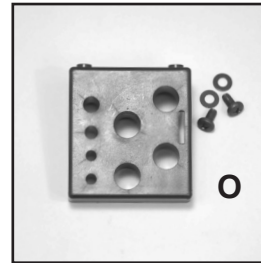

ADDITIONAL TOOLS REQUIRED FOR ASSEMBLY & ADJUSTMENTS

#2 Phillips Screwdriver



Adjustable Wrench



Model 70-220VSR Wood Lathe is shipped complete in one box.

Unpacking and Clean-up

1. Carefully remove all contents from the shipping carton. Compare the contents with the list of contents to make sure that all of the items are accounted for, before discarding any packing material. Place parts on a protected surface for easy identification and assembly. If any parts are missing or broken, please call RIKON Customer Service (877-884-5167) as soon as possible for replacements. **DO NOT** turn your machine ON if any of these items are missing. You may cause injury to yourself or damage to the machine.
2. Report any shipping damage to your local distributor. Take photographs for any possible insurance claims.
3. Clean all rust protected surfaces with ordinary household type grease or spot remover. Do not use flammables; gasoline, paint thinner, mineral spirits, etc. These may damage painted surfaces. Clean thoroughly under the headstock, tailstock and tool rest body. Then coat with a light film of dry lubricant spray, or wax, to enhance passage of the tool rest and tailstock on/over the bed. Refrain from using any water-based solvents as they will promote metal rusting.
4. Apply a coat of paste wax to any machined surfaces to prevent rust. Wipe all parts thoroughly with a clean dry cloth.
5. Set packing material and shipping carton aside. Do not discard the packing material until the machine has been set up and is running properly, in case a return is necessary.

GETTING TO KNOW YOUR MACHINE

- A. Motor, Mounting Plate & Locking Handle
- B. Outboard Bed Cover Plate Door
- C. Headstock
- D. Spindle Lock Knob / Index Pin
- E. Outboard Hand Wheel
- F. Headstock Cover
- G. Spindle with Spur Center
- H. Tool Rest & Base Assembly
- I. Tool Rest Locking Handle
- J. Tool Rest Base Locking Lever
- K. Live Center
- L. Tailstock Assembly
- M. Face Plate
- N. Electronic Controls
 - ON/OFF Switch
 - Forward / Reverse Switch
 - Speed Control Knob
 - Digital Speed Readout
- O. Lathe Bed
- P. Power Cord
- Q. Tailstock Locking Lever
- R. Tailstock Hand Wheel
- S. Tailstock Locking Handle
- T. Tool Holder & Tools

** Midi Lathe shown on #70-920 Stand

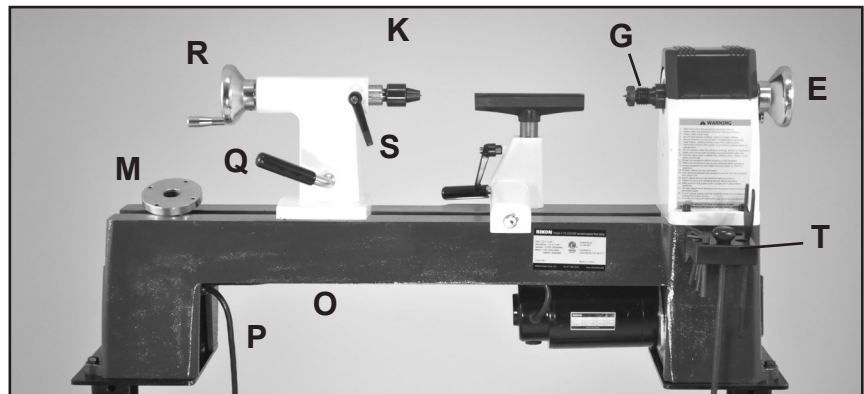
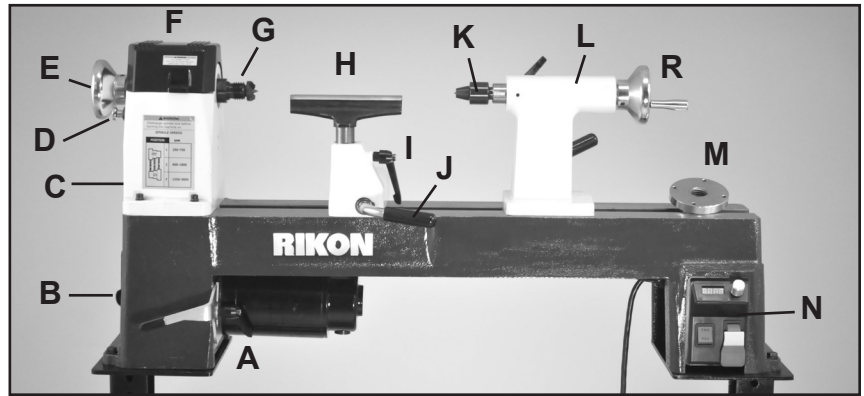

INSTALLATION

MOVING & INSTALLING THE LATHE

1. When moving the lathe, **DO NOT** use the headstock assembly, motor, tool rest or tailstock as this may damage the machine. Hold under the lathe's bed to lift and move the machine. Straps or battens placed under the lathe bed can also be used to move the machine.
2. Position the machine on a solid stand, or bench, that is located in an area that has ample space in front and in back of the lathe for working and moving around the lathe.
3. For best power and safety, the lathe should be plugged directly into a dedicated grounded electrical outlet that is within the supplied cord length of the machine. The use of an extension cord is not recommended.
4. Align the machine so that during use, any turning debris or kickback will not face aisles, doorways, or other work areas that bystanders may be in. Do not locate or use the machine in damp or wet conditions.
5. Once in place in your shop, make sure that the machine is level. If possible, secure the machine, or stand to the floor, or bench, with lag screws (not supplied). This will reduce any possible vibration during use.

ASSEMBLY

The 70-220VSR Lathe requires only minor assembly to become operational. See the photos above for reference.

1. Install the Outboard Hand Wheel on the Headstock. Tighten it in place on the spindle with the two set screws.
2. Install the Tailstock Hand Wheel onto the tailstock spindle. Secure with the set screw on the flat spindle area.
3. Install the Tool Holder onto the back of the headstock with the two Phillips head screws and washers provided.
4. Install the 8" Tool Rest into the Tool Rest Base.
5. The Faceplate may be shipped pre-installed on the headstock spindle. If plate or bowl turning is to be done, then the use of the faceplate is needed. To remove the faceplate, loosen the two set screws in the rear hub of the faceplate, then unscrew the faceplate from the spindle (counter-clockwise rotation). Two wrenches are supplied for this.
6. For spindle turning, remove the faceplate. Install the Spur Center into the headstock spindle and Live Center into the tailstock spindle. Both have #2 Morse Taper shanks.
7. Secure the lathe to a solid work surface or stand.

OPERATION

HEADSTOCK CONTROLS

1. **HEADSTOCK SPINDLE LOCK:** The spring loaded Index Pin Assembly (#44, FIG. 1, A) is primarily used to position the spindle for making accurate, spaced pattern work on projects such as straight fluting, grooving, drilling, detail carving, wood burning patterns and laying out designs. See page 13 for more information.

The Index Pin will also keep the spindle from turning, so if necessary, faceplates, chucks or other accessories that have been mounted on the threaded spindle can be removed. **NOTE:** Do not put excessive pressure on the Index Pin when trying to remove accessories from the lathe, or damage to the pin, or spindle pulley, may result.

The Index Pin is spring loaded. Pull the Pin out, so that its Roll-Pin is removed from the 'high' grooves in the Locating Sleeve. Rotate the pin 90° to position the roll-pin back into the Sleeve. The deeper groove locations will insert the Index Pin's shaft into the Spindle pulley's hole(s), locking the spindle in place. To unlock the spindle, reverse the process.

2. **HEADSTOCK INDEXING HOLES:** (FIG. 1, B) The largest Spindle Pulley (#52, B) has 24 positioning holes located around its left side. Each index hole is 15° apart, and marked for reference around the perimeter of the pulley. Insert the Indexing Pin (A) into one of these holes, and the spindle will be locked so that work can be done on the workpiece. See page 13 for additional information.

CAUTION Never start the lathe with the index pin engaged in the spindle, or damage to the machine will result.
- Never engage the headstock spindle lock while the spindle is turning, or damage to the lathe will result.

3. **HEADSTOCK FACEPLATE:** Faceplates (#58, FIG. 2, A) are used for turning bowls and plates. There are a number of screw holes on the plate for mounting the workpiece for turning. Thread the faceplate onto the spindle in a clockwise direction, and tighten it in place with the set screws that are located on the back hub of the faceplate. To remove the faceplate, loosen the set screws. Use one wrench on the flat portion of the spindle (X) and another wrench on flats of the faceplate's rear hub, then loosen the faceplate from the spindle. Rotate the faceplate counter-clockwise to fully remove it from the spindle.

4. **HEADSTOCK SPUR CENTER:** The Spur Center (#59, FIG. 2, B) is used for turning between centers. It fits into the spindle. Both spindle and the spur center have matching MT-2 tapers. The spur center can be removed from the spindle with the long Knockout Bar, inserted through the outboard left end of the spindle. **NOTE:** Be careful and hold the spur center during this process so it does not fly out onto the floor. A short Knockout Bar is supplied to remove the Spur Center's Center Point, if it needs replacing.

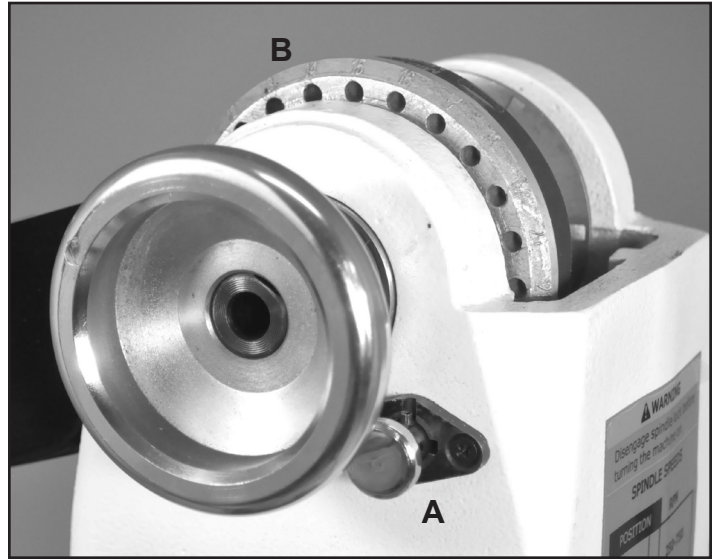

FIG. 1

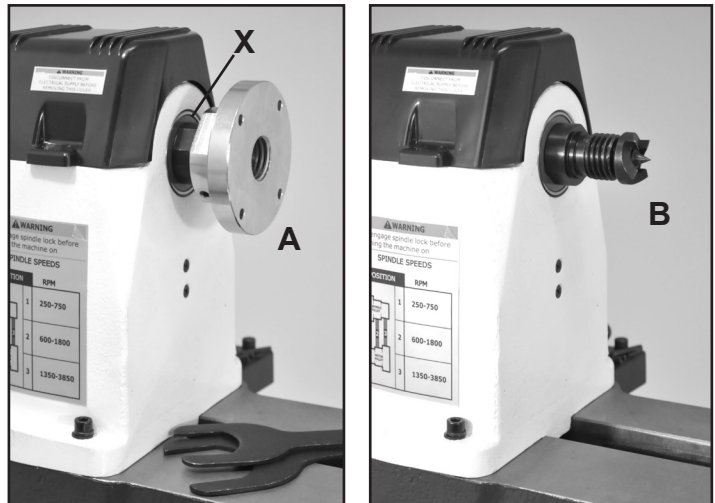

FIG. 2

DIAMETER OF WORK	ROUGHING RPM	GENERAL CUTTING RPM	FINISHING RPM
Under 2"	1520	3200	3200
2 to 4"	750	1600	2480
4 to 6"	510	1080	1650
6 to 8"	380	810	1240
8 to 10"	300	650	1000
10 to 12"	255	540	830
12 to 14"	220	460	710
14 to 16"	190	400	620

FIG. 3

OPERATION

TOOL REST CONTROLS

1. **TOOL REST BODY LOCK HANDLE:** (FIG. 4, A) This cam action lever handle locks the tool rest base (B) down in position on the lathe bed. Unlock handle to position the tool rest in any location along the lathe bed. Tighten the handle when the tool rest is properly located for safe turning of the workpiece.

2. **TOOL REST LOCK HANDLE:** (C) Locks the tool rest in position for supporting your tools during turning. Unlock the handle to adjust the tool rest at a specific angle, or height. Tighten handle when properly positioned.

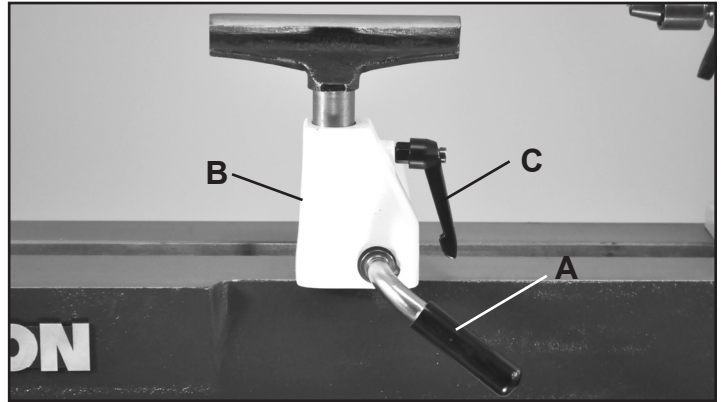

FIG. 4

TAILSTOCK CONTROLS

1. **TAILSTOCK LOCK HANDLE:** (FIG. 5, D) Locks the tailstock in position along the length of the lathe bed. Unlock handle to position the tool rest to move the tailstock. Tighten handle when properly positioned.

2. **TAILSTOCK QUILL LOCK HANDLE:** (E) Secures the tailstock quill in position. Unlock the handle to move the quill, with live center, forward or backwards. Tighten the locking handle when the quill is finally positioned.

3. **TAILSTOCK QUILL HANDWHEEL:** (F) The handwheel advances or retracts the quill 0 to 3-1/2". The tailstock quill lock handle (E) must be loose to move the quill.

4. **TAILSTOCK LIVE CENTER:** (G) Used for turning between centers. The Live Center (#84) and the Quill (#83) have MT-2 tapers. Remove the live center by retracting the quill until the center loosens, or use the knockout bar.

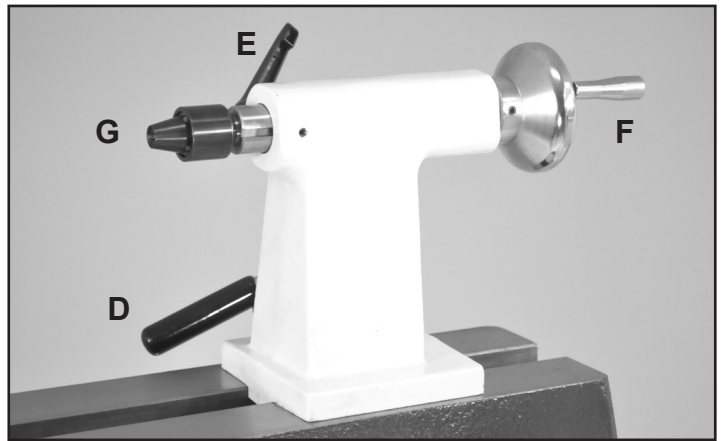

FIG. 5

ELECTRONIC CONTROLS

1. **ON/OFF SWITCH:** (FIG. 6, A) The safety, paddle ON/OFF switch is located on the right foot of the lathe for quick, easy and safe access. Lift the paddle to turn the lathe on. Push the paddle down to turn the lathe OFF. A safety lock insert (B) is included in the switch. This can be removed to disable the switch, so that the machine can not be turned on by accident, or by children.

2. **SPEED RPM KNOB:** (C) This knob controls the desired spindle revolutions per minute (RPM). The lathe has three speed ranges - 250-750, 550-1650, 1300-3850 RPM. See the Speed Chart (FIG. 3, page 9) for recommended speeds based on the diameter of the workpieces.

3. **SPEED RPM DIGITAL READOUT:** (D) Displays the spindle's RPM as set by the RPM Knob (C).

4. **FORWARD / REVERSE SWITCH:** (E) This toggle switch will change the direction that the spindle turns - counter-clockwise (forward) or clockwise (reverse).

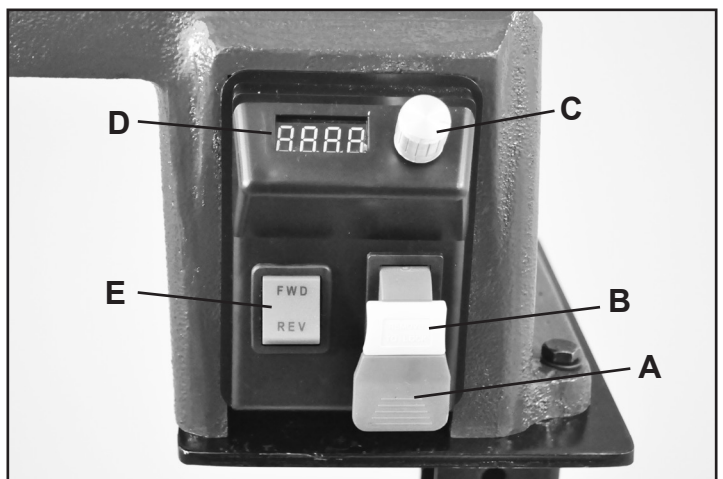

FIG. 6

CAUTION Only change rotation direction when the spindle has completely stopped. Should the switch be changed while the lathe is operating, the machine will automatically turn off in 'protection' mode. The Digital Readout will show an error code reading. Turn off the lathe's ON/OFF switch and the digital reading will go out, and the control box will reset. Then put the forward/reverse switch to the desired setting (FWD or REV) and the lathe can be turned back on to continue your work.

NOTE: See page 14 for a list of Electronic Digital Codes.

ADJUSTMENTS

⚠ WARNING THE MACHINE MUST NOT BE PLUGGED IN AND THE POWER SWITCH MUST BE IN THE OFF POSITION UNTIL ALL ADJUSTMENTS ARE COMPLETE.

CHANGING BELT SPEEDS

1. Unplug the lathe from the power source.
2. Open the top Headstock Cover (#35, FIG. 7, A) and the left side, Bed Cover Plate Door (#8, B) to gain access to the belt and pulleys that are inside of the headstock.
3. Loosen the motor mount Locking Handle (#21, C).
4. Lift the Motor Connecting Plate Handle (#19, D) to loosen the tension on the Poly V-Belt (#16). The belt can now be re-positioned on the upper Spindle Pulley (#52) and lower Motor Pulley (#14, E) for the desired speed range setting. FIG. 8 shows the belt positions for the three speeds.

NOTE: The 'High' speed range (1,300-3850 RPM) provides maximum speed. The 'Low' speed range (250-750 RPM) will provide maximum torque. See the Speed Chart on page 9, FIG. 3, for recommended speeds based on the diameter of the workpieces being turned.

4. With the Poly V-Belt positioned on the pulleys, lower the Motor Connecting Plate so that the weight of the motor provides the needed tension on the belt. Then re-tighten the Locking Handle that was loosened in step 3, above.
5. Close the Headstock Cover and Bed Cover Plate Door to protect the belt, pulleys and internal working from dust.

ADJUSTING THE LOCKING HANDLES

The locking handles on the tailstock and tool rest are pre-set at the factory to give ample holding pressure against the lathe bed to keep these lathe assemblies positioned, so that they will not move during use.

If adjustments are needed, the clamping pressure can be changed by turning the large Hex Nuts (#32 & 67) that are located under the lathe bed and below the assemblies. This can be done with an adjustable wrench (not included). FIG. 9 shows the tool rest removed from the lathe bed to view the locking mechanism and Hex Nut (A).

1. Loosen the Locking Handle (B) so that there is no clamping pressure being exerted on the lathe assembly.
2. With a wrench, slightly turn the Hex Nut to loosen or tighten it on its Threaded Shaft (#30 & 71).
3. Test the clamping pressure with the locking handle, and adjust the nut again, if needed, to set the right pressure.

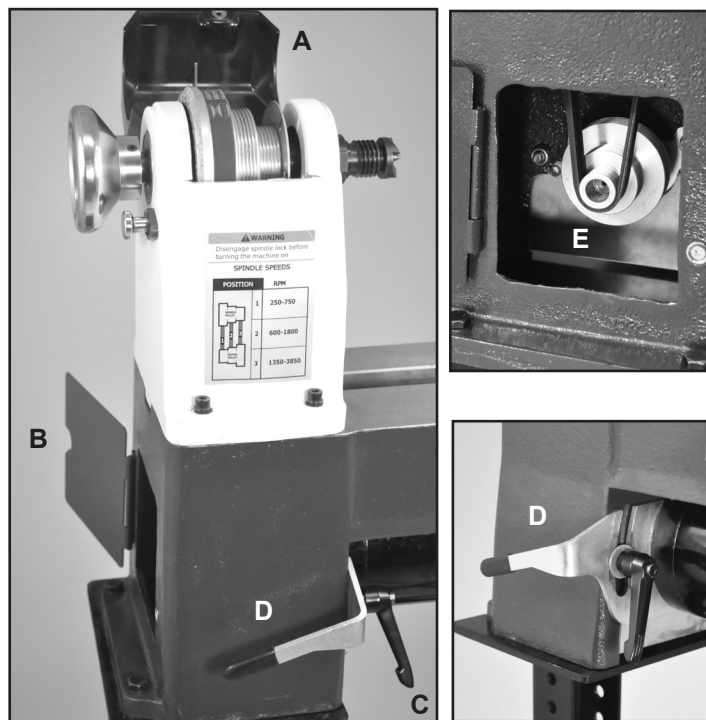

FIG. 7

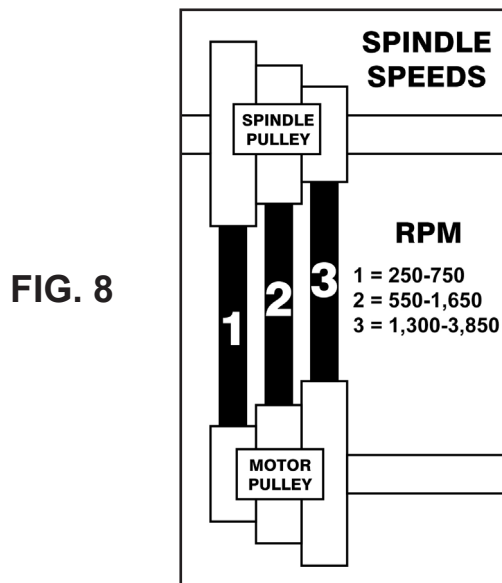

FIG. 8



FIG. 9

ADJUSTMENTS

CHANGING THE BELT

To change the belt, the whole spindle shaft needs to be shifted right, out of the headstock, towards the tailstock. This will allow the new belt to be slipped over the spindle and onto the spindle pulley. Then the whole spindle shaft assembly can be re-installed so turning can be resumed.

1. Unplug the lathe from the power source.
2. Remove any accessories from the spindle - spur center, face plate, chuck, etc.
3. Open the top Headstock Cover (#35, FIG. 10, A) and the left side, Bed Cover Plate Door (#8, B) to gain access to the belt and pulleys that are inside of the headstock.
4. Loosen the motor mount Locking Handle (#21, C).
5. Lift the Motor Connecting Plate Handle (#19, D) to loosen the tension on the Poly V-Belt (#16). The belt can now be removed from the lower Motor Pulley (#14, E).
6. Loosen the two (2) Set Screws (#40) that attach the Hand Wheel (#41, E) to the spindle, and remove the Hand Wheel.
7. Remove the two countersunk Phillips Screws (#33B) that hold the RPM Reader and Support Bracket assemblies (#49, 48, 48A-F), which are located under the Spindle Pulley's Segmented Plate (#53, G). This will drop the RPM Reader inside of the headstock and safely away from the spindle pulley. FIG. 11. See Parts Diagram on page 18.
8. Remove the Set Screws (#51, H) that attach the Spindle Pulley to the spindle. The pulley should now be loose on the spindle. **NOTE:** There are two (2) set screws, one on top of the other, in both of the two (2) threaded holes. This stacking keeps the set screws from loosening during use.
9. Remove the Retaining C-Clip (#39) that is on the outside, left end of the spindle where the hand wheel was.
10. Carefully knock the spindle, towards the tailstock. Use a block of wood against the spindle end to prevent any damage when it is hit with a mallet/hammer. The spindle pulley, now loose, will slide along the spindle.
11. Remove the old belt, if present, and install the new belt over the spindle pulley. Return the pulley back onto the spindle, and re-install the spindle back into the headstock casting. As in step 10, carefully knock the spindle and bearings into place with a block of wood and mallet.
12. Secure the spindle pulley in place on the spindle with the set screws. Make sure that the set screws engage back onto the flat sections on the spindle to eliminate slippage.

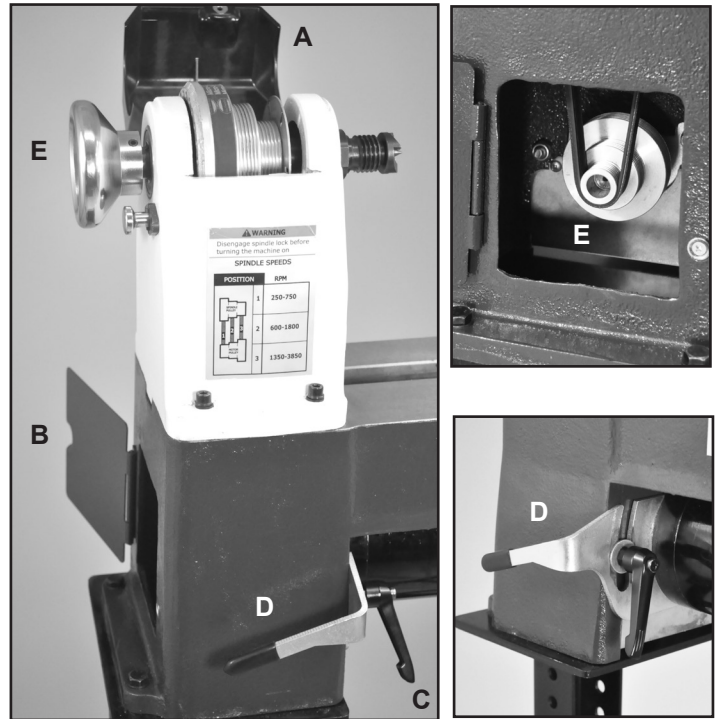

FIG. 10

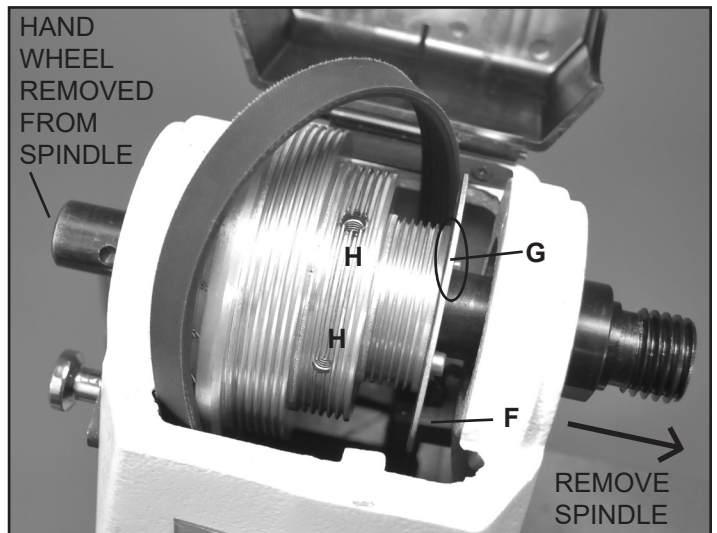

FIG. 11

13. Re-install the RPM Reader & Support Bracket that were unscrewed in step 7. The Reader's elements are 'U' shaped and must be positioned so that the Segmented Plate is in the middle of the two Reader's elements. You will have to reach up inside the headstock to position the bracket to take the two screws. HINT: Use an awl, stiff wire or toothpick to help align the bracket's threaded holes with the countersunk holes in the headstock. This will make re-fastening the screws easier.

14. Re-assemble the remaining headstock parts by reversing the procedure previously described.

ADJUSTMENTS

CHANGING THE BEARINGS

To change the bearings, the whole spindle shaft needs to be shifted right, out of the headstock, towards the tailstock. Then the bearings can be removed from the headstock casting. With the new bearings in place, the spindle shaft assembly can be re-installed, so turning can be resumed.

1. Follow the steps 1-10 described in CHANGING THE BELT on page 12 to remove the spindle assembly from the headstock.

2. Carefully knock out the old bearings. Use a block of wood against the bearings to prevent any damage to the machine, if it is mistakenly hit with a mallet/hammer. Do not remove the large Retaining C-Clips (#55) from the castings. These clips properly position the bearings when in place.

WARNING THE MACHINE MUST NOT BE PLUGGED IN AND THE POWER SWITCH MUST BE IN THE OFF POSITION UNTIL ALL ADJUSTMENTS ARE COMPLETE.

3. Install the two new Bearings (#38 & 56) in the headstock, by carefully knocking them into position.

4. Re-assemble the lathe parts by reversing the procedure described in steps 11 - 14 as described in the CHANGING THE BELT instructions on page 12.

NOTE: The lathe's ball bearings are lifetime lubricated, sealed, and do not need any further care. To prevent slipping, keep the drive belt free of oil and grease.

SPINDLE INDEXING ADJUSTMENTS

The Headstock Spindle has 24 indexing holes, each 15° apart, which allows accurate pattern work on projects such as straight fluting, grooving, drilling, detail carving, wood burning patterns, laying out designs and more.

The Indexing Chart, FIG. 12, shows how to rotate the spindle to access any of the 24 indexing holes. The 8 primary settings are listed in FIG. 13, however, other indexing/design settings are possible. Vary the index combinations to make non-equal, spaced patterns. Also, by rotating/re-positioning your work while it is being held between centers, in a chuck or on a faceplate, new orientation points for the index holes will be set for your work.

To Use: Insert the Indexing Pin into one of the 24 spindle's positioning holes according to the chart, and the number of setting you need for your workpiece. Make sure that the pin locates and securely enters into one of the indexing holes so that there is no accidental slipping.

With the Indexing Pin in the first spindle hole setting, do your work (drilling /marking/etc.), then rotate the spindle to the next index setting noted on the chart. Work through all of the designated index setting numbered positions and complete the remaining markings, or work, on your workpiece.

WARNING NEVER START THE LATHE WITH THE INDEX PIN ENGAGED IN THE SPINDLE, OR DAMAGE TO THE MACHINE WILL RESULT.

See page 9 for additional information on the lathe's headstock and indexing.

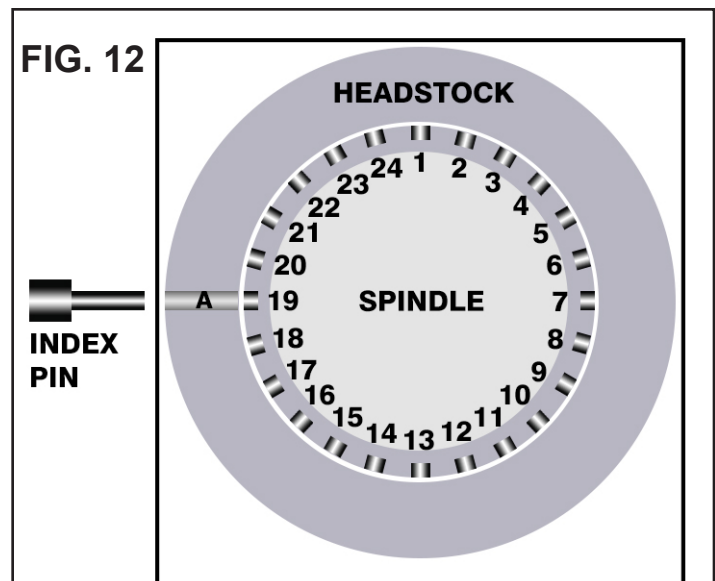

NUMBER OF INDEX POSITIONS	ANGLE BETWEEN POSITIONS	HEADSTOCK INDEX LETTER	SPINDLE INDEX NUMBER
1	360°	A	1
2	180°	A	1,13
3	120°	A	1,9,17
4	90°	A	1,7,13,19
6	60°	A	1,5,9,13,17,21
8	45°	A	1,4,7,10,13,16,19,22
12	30°	A	1,3,5,7,9,11,13,15,17,19,21,23
24	15°	A	1 to 24

FIG. 13

MAINTENANCE

WARNING: Turn the power switch “OFF” and disconnect the plug from the outlet prior to adjusting or maintaining the machine. DO NOT attempt to repair or maintain the electrical components of the motor. Contact a qualified service technician for this type of maintenance.

1. Before each use:
 - Check the power cord and plug for any wear or damage.
 - Check for any loose screws, hardware, locking handles, jigs or various lathe accessories.
 - Check the area to make sure it is clear of any misplaced tools, lumber, cleaning supplies, etc. that could hamper the safe operation of the machine.
 2. Avoid a build-up of wood shavings and dust. Regularly clean all parts of the machine using a soft cloth, brush or compressed air. A general cleaning should be done after every use to avoid future problems and ensure that the machine is in ready condition for its next use.
 3. Keep the lathe bed free of resin and rust. Clean it regularly with a non-flammable solvent, then coat with a light film of dry lubricant spray, or wax, to enhance passage of the tool rest and tailstock on/over the bed.
 4. Keep the lathe tools sharp, and make sure the steel is not loose in the handles so that no accidents might occur. Making sure that tools are in proper operating condition will ensure that the quality of your turning will be the best possible.
 5. Check all lathe accessories (spur centers, live centers, chucks, tool rests, etc) to ensure that they are in perfect working condition.
 6. The lathe’s ball bearings are lifetime lubricated, sealed, and do not need any further care. Keep the drive belt free of oil and grease to prevent slipping on the pulleys.
- WARNING:** If blowing sawdust, wear a proper dust mask and eye protection to prevent debris from being inhaled and blowing into your eyes.

TROUBLESHOOTING

Electronic Speed Control ACTION CODES

DISPLAY CODE	CONDITION	ACTION
01	Hardware Protection Mode - Possible damage to the electronic controller.	Turn off the machine and re-start once the digital display has cleared. If the error code still appears, the controller hardware may be damaged and Technical Support should be contacted.
02	Software Protection Mode - Possible damage to the electronic controller.	Turn off the machine and re-start once the digital display has cleared. If the error code still appears, the controller hardware may be damaged and Technical Support should be contacted.
03	Low Voltage Abnormality Protection Mode - Voltage is lower than 85V.	It is normal for this error code to appear for a short period after turning the machine off. If it appears during operation, turn off the machine and re-start once the digital display has cleared. If the code is still shown, the power supply must be corrected.
05	Sensor Problem - There is no signal from the speed sensor. After 1 minute, the error code will be changed to Error 10.	The Sensor Connector is loose and all wiring connections need to be checked, or a new replacement sensor is needed.
06	Spindle Direction Protection Mode - The spindle direction has been changed during operation.	Turn off the machine and re-start it once the digital display has cleared.
07	High Voltage Abnormality Protection Mode - Voltage is higher than 135V.	Turn off and re-start the machine. If the error code still appears, check and correct the power supply.
08	Motor Speed Protection Mode - Motor speed has been increased sharply, indicating possible user error.	Turn off and re-start the machine. If the error code still appears, the motor or controller may be damaged.
10	Sensor Problem - From Error Code 5, if there is no signal from the speed sensor, after 1 minute, the error code is changed to Error 10.	The Sensor Connector is loose and all wiring connections need to be checked, or a new replacement sensor is needed.

TROUBLESHOOTING

PROBLEM	PROBABLE CAUSE	REMEDY
Motor will not start	<ol style="list-style-type: none"> 1. Machine is not plugged in 2. Low voltage 3. Loose connection 	<ol style="list-style-type: none"> 1. Plug in machine 2. Check fuses 3. Check plug and all connections
Motor fails to develop full power.	<ol style="list-style-type: none"> 1. Power line is overloaded 2. Undersize wires in supply system 3. Drive belt tension is too high 4. Low voltage 5. Worn motor 	<ol style="list-style-type: none"> 1. Correct the overload condition 2. Increase supply wire size or eliminate extension cord if one is used 3. Adjust belt tension 4. Have voltage checked by an electrician and corrected, if necessary 5. Replace the motor
Motor or Spindle Stalls or will not start	<ol style="list-style-type: none"> 1. Excessive depth of cut 2. Loose or broken belt 3. Worn spindle bearings 4. Improper cooling of motor 5. Worn motor 	<ol style="list-style-type: none"> 1. Reduce cutting depth 2. Check tension or replace drive belt 3. Replace bearings 4. Clean motor to increase air flow, or reduce motor running time 5. Replace Motor
Motor overheats	<ol style="list-style-type: none"> 1. Motor is overloaded 2. Air flow restricted on the motor 	<ol style="list-style-type: none"> 1. Reduce load on the motor 2. Clean motor to increase air flow
Excessive Vibration.	<ol style="list-style-type: none"> 1. Workpiece is warped, out of round, has major flaw, or was improperly prepared or centered for turning 2. Worn spindle bearings 3. Worn belt 4. Motor mount bolt or handles are loose 5. Lathe is on an uneven surface 	<ol style="list-style-type: none"> 1. Correct problem by planing, band sawing, or discard the workpiece 2. Replace the bearings 3. Replace the belt 4. Tighten all bolts or handles 5. Shim the lathe stand, or adjust the feet on the stand for stability
Tailstock Moves when applying pressure	<ol style="list-style-type: none"> 1. Excessive pressure being applied by the tailstock onto the workpiece 2. Tailstock is not secured in place 3. Lathe bed and tailstock mating surfaces are greasy or oily. 	<ol style="list-style-type: none"> 1. Apply only sufficient force with the tailstock to hold the workpiece securely between centers. 2. Tighten tailstock locking lever 3. Remove tailstock and clean bed surfaces with a cleaner degreaser
Tailstock or Tool Rest Base do not lock in place	<ol style="list-style-type: none"> 1. Incorrect adjustment on locking lever mechanism 	<ol style="list-style-type: none"> 1. Adjust the nut under the clamping plate to increase (or decrease) the clamping pressure of the lock levers
Machine bogs down during cutting	<ol style="list-style-type: none"> 1. Excessive depth of cut is taken 2. Turning tools are dull 	<ol style="list-style-type: none"> 1. Decrease the depth of cut 2. Sharpen the turning tools
Tools tend to grab or dig in.	<ol style="list-style-type: none"> 1. Dull turning tools 2. Tool rest is set too low 3. Tool rest is set too far from the workpiece 4. Improper turning tool is being used 	<ol style="list-style-type: none"> 1. Sharpen the tools 2. Reposition the tool rest height 3. Set the tool rest closer to the workpiece 4. Use the correct tool for operation
Digital readout does not work	<ol style="list-style-type: none"> 1. Digital readout sensor out of position 	<ol style="list-style-type: none"> 1. Contact Technical Support at 877-884-5167 or email techsupport@rikontools.com

For parts or technical questions contact: techsupport@rikontools.com or 877-884-5167.

PARTS DIAGRAM

70-220VSR BED ASSEMBLY

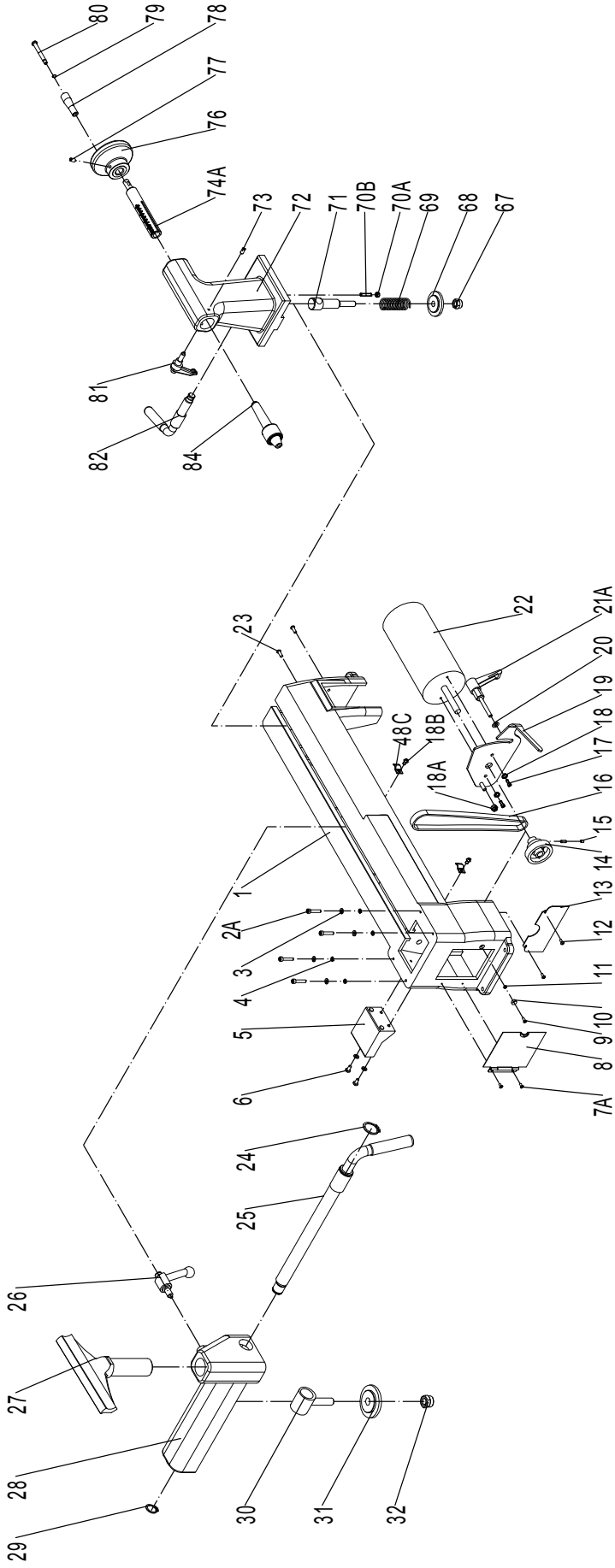

NOTE: Please reference the Manufacturer's Part Number when calling for Replacement Parts.

For Parts under Warranty, the Serial Number of your machine is required.

PARTS LIST

70-220VSR BED ASSEMBLY

KEY NO.	DESCRIPTION	QTY	MFG. PART NO.
1	Bed	1	70-220VSR-1
2A	Hexagon socket cap screw M6X35	4	70-220VSR-2A
3	Flat washer	6	70-220VSR-3
4	Lock washer	4	70-220VSR-4
5	Tool holder	1	70-220VSR-5
6	Cross pan head screw M6X12	2	70-220VSR-6
7A	Countersunk head screw M4X12	2	70-220VSR-7A
8	Bed cover plate door	1	70-220VSR-8
9	Countersunk head screw M4X12	1	70-220VSR-9
10	Magnet	1	70-220VSR-10
11	Nut M4	1	70-220VSR-11
12	Half-Countersunk head screw M4X10	2	70-220VSR-12
13	Plate	1	70-220VSR-13
14	Motor pulley	1	70-220VSR-14
15	Socket head cap screw M6X5	1	70-220VSR-15
16	Poly-v-belt	1	70-220VSR-16
17	Hex socket cap screw M6X16	2	70-220VSR-17
18	Lock washer	2	70-220VSR-18
18A	Self-locking nut M8	1	70-220VSR-18A
18B	Cross pan head screw M5X10	2	70-220VSR-18B
19	Motor connecting plate	1	70-220VSR-19
20	Big washer	1	70-220VSR-20
21A	Locking handle	1	70-220VSR-21A
22	Motor	1	70-220VSR-22
23	Hex socket cap screw M6X16	2	70-220VSR-23
24	Retaining ring	1	70-220VSR-24
25	Locking lever	1	70-220VSR-25
26	Locking handle	1	70-220VSR-26
27	8" Tool rest	1	70-220VSR-27
28	Tool rest base	1	70-220VSR-28
29	Retaining ring	1	70-220VSR-29
30	Threaded shaft & sleeve	1	70-220VSR-30
31	Clamping plate	1	70-220VSR-31
32	Self-locking nut M10	1	70-220VSR-32
48C	Cable plate	1	70-220VSR-48C
67	Self-locking nut M10	1	70-220VSR-67
68	Clamping plate	1	70-220VSR-68
69	Compression spring	1	70-220VSR-69
70A	Nut M5	1	70-220VSR-70A
70B	Set screw M5X25	1	70-220VSR-70B
71	Threaded shaft	1	70-220VSR-71
72	Tailstock	1	70-220VSR-72
73	Set screw M5X12	1	70-220VSR-73
74A	Axle Sleeve & Bolt Assembly	1	70-220VSR-74A
76	Hand wheel	1	70-220VSR-76
77	Socket head cap screw M6X8	1	70-220VSR-77
78	Rotation handle	1	70-220VSR-78
79	Spring coil	1	70-220VSR-79
80	Screw	1	70-220VSR-80
81	Locking handle	1	70-220VSR-81
82	Tailstock locking lever	1	70-220VSR-82
84	Live center	1	70-220VSR-84
85	Long Knockout Bar (not shown)	1	70-220VSR-85
86	Short Knockout Bar (not shown)	1	70-220VSR-86
87	Wrench - 32 mm (not shown)	1	70-220VSR-87
88	Wrench - 46 mm (not shown)	1	70-220VSR-88
89	Hex Wrench - 3mm (not shown)	1	P-HEX3
90	Hex Wrench - 4mm (not shown)	1	P-HEX4
91	Hex Wrench - 5mm (not shown)	1	P-HEX5

PARTS DIAGRAM

70-220VSR HEADSTOCK ASSEMBLY

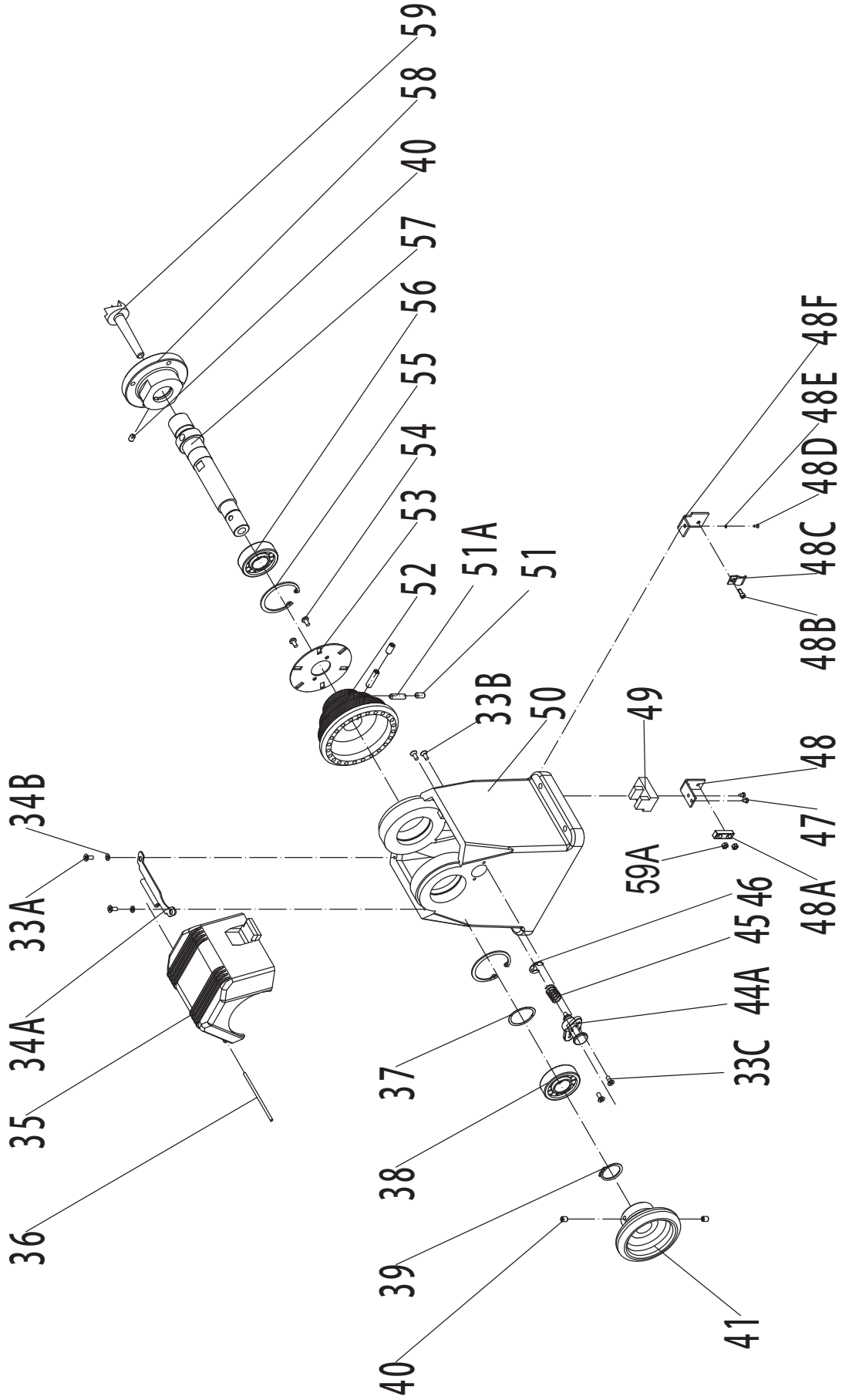

NOTE: Please reference the Manufacturer's Part Number when calling for Replacement Parts.
For Parts under Warranty, the Serial Number of your machine is required.

PARTS LIST

KEY NO.	DESCRIPTION	QTY	MFG. PART NO.
33C	Countersunk head screw M4X12	2	70-220VSR-33C
33A	Screw M4X10	2	70-220VSR-33A
33B	Cross pan head screw M4X16	2	70-220VSR-33B
34A	Hinge	1	70-220VSR-34A
34B	Flat washer	2	70-220VSR-34B
35	Headstock cover	1	70-220VSR-35
36	Hinge shaft	1	70-220VSR-36
37	Wave washer	1	70-220VSR-37
38	Bearing	1	70-220VSR-38
39	Retaining ring	1	70-220VSR-39
40	Socket head cap screw M6X8	5	70-220VSR-40
41	Hand wheel	1	70-220VSR-41
44A	Index pin knob & shaft	1	70-220VSR-44A
45	Spring	1	70-220VSR-45
46	Split washer	1	70-220VSR-46
47	Tapping screw	2	70-220VSR-47
48	Support bracket	1	70-220VSR-48
48A	Threaded plate	1	70-220VSR-48A
48B	Cylinder head hex socket bolt M5X8	1	70-220VSR-48B
48C	Cable plate	3	70-220VSR-48C
48D	Cross pan head screw M4X8	1	70-220VSR-48D
48E	Flat washer	1	70-220VSR-48E
48F	Plate	1	70-220VSR-48F
49	Sensor module Assembly	1	70-220VSR-49
50	Headstock	1	70-220VSR-50
51	Socket head cap screw M6x6	2	70-220VSR-51
51A	Socket head cap screw M6x16	2	70-220VSR-51A
52	Spindle pulley	1	70-220VSR-52
53	Segmented RMP plate	1	70-220VSR-53
54	Hexagon socket cap screw M4X10	2	70-220VSR-54
55	Retaining ring C-clip	2	70-220VSR-55
56	Bearing	1	70-220VSR-56
57	Spindle	1	70-220VSR-57
58	3" Face plate	1	70-220VSR-58
59	Spur center	1	70-220VSR-59
59A	Hex nut	2	70-220VSR-59A

70-220VSR HEADSTOCK ASSEMBLY

PARTS DIAGRAM & PARTS LIST

70-220VSR CONTROL BOX ASSEMBLY

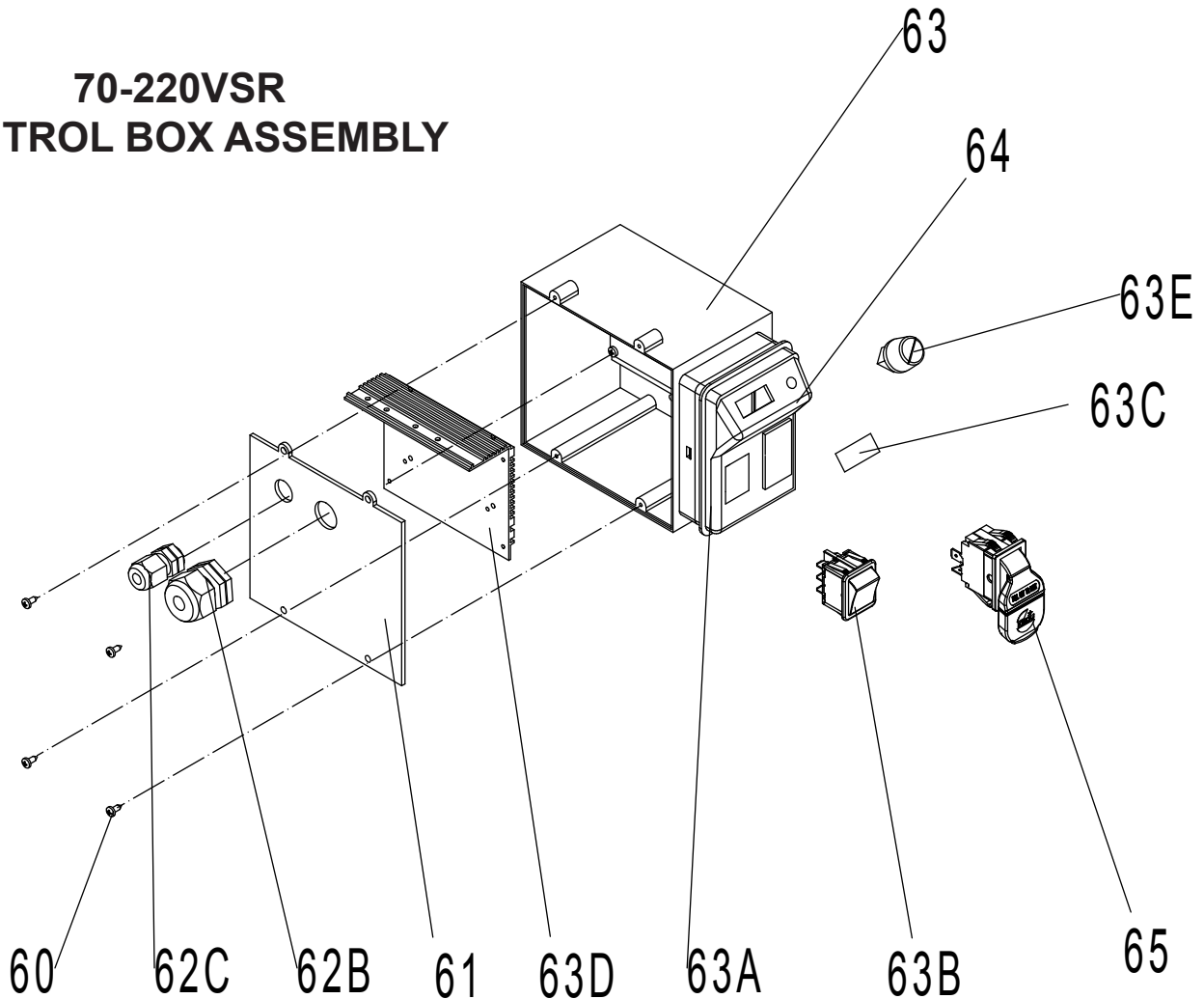

KEY NO.	DESCRIPTION	QTY	MFG. PART NO.
60	Tapping screw	4	70-220VSR-60
61	Electric box cover	1	70-220VSR-61
62B	M20 Pull off	1	70-220VSR-62B
62C	M16 Pull off	1	70-220VSR-62C
63	Electric box	1	70-220VSR-63
63A	Control box	1	70-220VSR-63A
63B	Switch	1	70-220VSR-63B
63C	Digital readout	1	70-220VSR-63C
63D	Actuator	1	70-220VSR-63D
63E	Knob	1	70-220VSR-63E
63EA	Speed control assembly *	1	P70-220VSR-64A1
64	Switch box	1	70-220VSR-64
65	Key switch	1	70-220VSR-65

* Not Shown

NOTE: Please reference the Manufacturer's Part Number when calling for Replacement Parts.
For Parts under Warranty, the Serial Number of your machine is required.

WIRING DIAGRAM



WARNING: This machine must be grounded. Replacement of the power supply cable should only be done by a qualified electrician. See page 5 for additional electrical information.

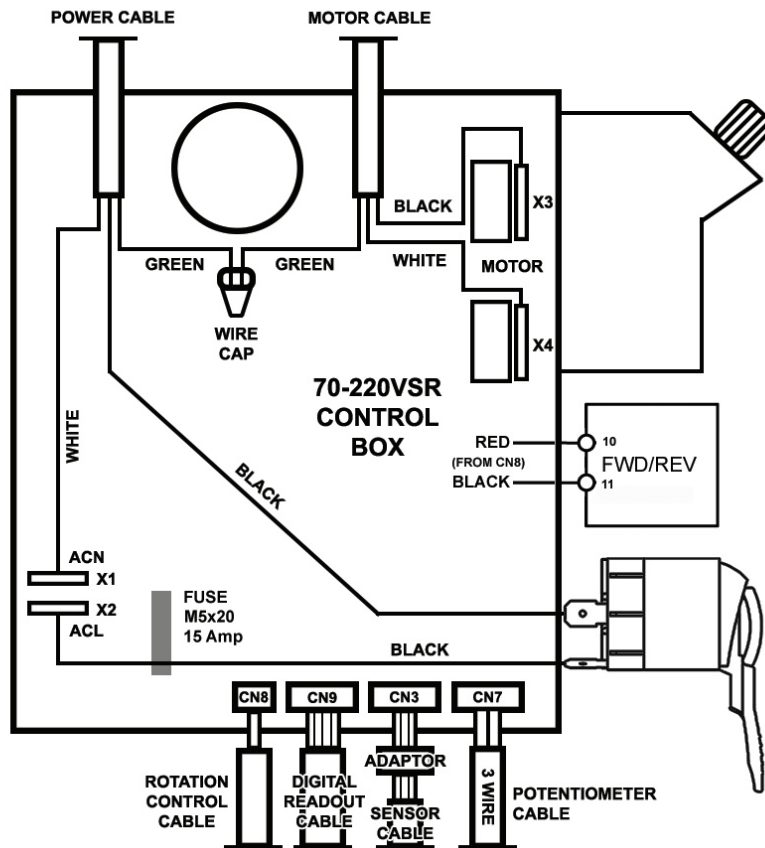

This tool is intended for use on a circuit that has a 120 volt electrical receptacle. The illustration on page 5 shows the type of the 120v, 3-wire electrical plug and electrical receptacle that has a grounding conductor that is required.



ACCESSORIES

70-901 24" LATHE BED EXTENSION

Made of heavy cast iron, it bolts to the right end of the 70-220VSR Midi Lathe to extend the lathe's working spindle length capacity to 44".



70-920 LATHE STAND

Universal, all-steel Stand adjusts from 23-1/4" to 37-1/4" long, and 24-1/2" to 34-1/2" working height.



70-913 LATHE STAND EXTENSION

Universal, all-steel Stand Extension bolts onto the 70-910 and 70-920 stands to support lathes with Bed Extensions. The stand extension adjusts from 18-3/4" to 32-1/4" long, and 24-1/2" to 34-1/2" working height.



ADDITIONAL LATHE ACCESSORIES

For additional lathe accessories or replacement parts, contact your local RIKON distributor, or visit the RIKON website at www.rikontools.com.

Tool rests, Face Plates, Drive Centers, Spur & Live Centers, Drill Chuck & Arbor, Drive Belts, etc.

RIKON

POWER TOOLS®

5-Year Limited Warranty

RIKON Power Tools Inc. ("Seller") warrants to only the original retail consumer/purchaser of our products that each product be free from defects in materials and workmanship for a period of five (5) years from the date the product was purchased at retail. This warranty may not be transferred.

This warranty does not apply to defects due directly or indirectly to misuse, abuse, negligence, accidents, repairs, alterations, lack of maintenance or normal wear and tear. Under no circumstances will Seller be liable for incidental or consequential damages resulting from defective products. All other warranties, expressed or implied, whether of merchantability, fitness for purpose, or otherwise are expressly disclaimed by Seller. This five-year warranty does not cover products used for commercial, industrial or educational purposes. The warranty term for these claims will be limited to a two-year period.

This limited warranty does not apply to accessory items such as blades, drill bits, sanding discs, grinding wheels, belts, guide bearings and other related items.

Seller shall in no event be liable for death, injuries to persons or property, or for incidental, contingent, special, or consequential damages arising from the use of our products.

To take advantage of this warranty, proof of purchase documentation must be provided which has the date of purchase and an explanation of the complaint.

The Seller reserves the right to effect at any time, without prior notice, those alterations to parts, fittings, and accessory equipment which they may deem necessary for any reason whatsoever.

To register your machine online, visit RIKON at www.rikontools.com/warranty

To take advantage of this warranty, or if you have any questions, please contact us at 877-884-5167 or email warranty@rikontools.com



For more information:
16 Progress Road
Billerica, MA 01821

877-884-5167 / 978-528-5380
techsupport@rikontools.com



LINK TO RIKON WEBSITE