

## Wall Mounted 1HP DUST COLLECTOR



# Operator's Manual

Record the serial number and date of purchase in your manual for future reference.

The serial number can be found on the specification label on the side of your machine.

Serial Number: \_\_\_\_\_ Date of purchase: \_\_\_\_\_

For technical support, email [techsupport@rikontools.com](mailto:techsupport@rikontools.com) - For parts questions, email [parts@rikontools.com](mailto:parts@rikontools.com)

## TABLE OF CONTENTS

Specifications .....	2
Safety Warnings.....	3-6
Electrical Requirements .....	5, 14
Dust Collector Safety Rules .....	6
Contents of Package .....	7
Assembly .....	8-10
Operation.....	11
Dust Hazards and Safety.....	6, 11
Accessories .....	11
Parts Diagram .....	12
Parts List .....	13
Wiring Diagram.....	14
Trouble Shooting.....	14
Maintenance .....	15
Warranty .....	15

## SPECIFICATIONS #60-101

Motor .....	1HP, TEFC
Motor Speed (no load).....	3,450 RPM
Volts .....	120 V / 240 V
Amps, Hertz, Phase .....	7 A / 3.5 A, 60 Hz, 1 Ph
Dust Collection Velocity CFM .....	800 @ 4" or 1,100 @ 5" inlet
Max. Static Pressure (at 0 CFM) .....	7.2"
Blower Impeller .....	10" Diameter, Aluminum
Sound Rating @ 6 Feet .....	<86.375 dB
Canister Filtration Rating .....	1 Micron
Canister Pleated Filter Size .....	19-5/8" (500mm) x 7-1/8" (180mm)
Total Pleated Filter Surface .....	13.46 sq/ft
Plastic Bag Length (installed) .....	20"
Plastic Bag Capacity .....	1.5 Cu. Ft.
Dust Ports / Hose Connections .....	1 @ 5", 2@4"
Intake Funnel Size .....	5" diameter
Overall Size (LxWxH) .....	23-1/2" x 21" x 46"
Net Weight .....	61 lbs.

**NOTE:** The specifications, photographs, drawings and information in this manual represent the current model when the manual was prepared. Changes and improvements may be made at any time, with no obligation on the part of Rikon Power Tools, Inc. to modify previously delivered units. Reasonable care has been taken to ensure that the information in this manual is correct, to provide you with the guidelines for the proper safety, assembly and operation of this machine.

# SAFETY INSTRUCTIONS

**IMPORTANT!** Safety is the single most important consideration in the operation of this equipment. **The following instructions must be followed at all times.** Failure to follow all instructions listed below may result in electric shock, fire, and/or serious personal injury.

There are certain applications for which this tool was designed. We strongly recommend that this tool not be modified and/or used for any other application other than that for which it was designed. If you have any questions about its application, do not use the tool until you have contacted us and we have advised you.

## SAFETY SYMBOLS



**SAFETY ALERT SYMBOL:** Indicates DANGER, WARNING, or CAUTION. This symbol may be used in conjunction with other symbols or pictographs.



Indicates an imminently hazardous situation, which, if not avoided, could result in death or serious injury.



Indicates a potentially hazardous situation, which, if not avoided, could result in death or serious injury.



Indicates a potentially hazardous situation, which, if not avoided, could result in minor or moderate injury.

**NOTICE:** Shown without Safety Alert Symbol indicates a situation that may result in property damage.

## GENERAL SAFETY

**KNOW YOUR POWER TOOL.** Read the owner's manual carefully. Learn the tool's applications, work capabilities, and its specific potential hazards.

### BEFORE USING YOUR MACHINE

To avoid serious injury and damage to the tool, read and follow all of the Safety and Operating Instructions before operating the machine.

1. **WARNING:** Some dust created by using power tools contains chemicals known to the State of California to cause cancer, birth defects, or other reproductive harm. Some examples of these chemicals are:

- Lead from lead-based paints.
- Crystalline silica from bricks, cement, and other masonry products.
- Arsenic and chromium from chemically treated lumber.

Your risk from these exposures varies, depending on how often you do this type of work. To reduce your exposure to these chemicals: work in a well ventilated area and work with approved safety equipment, such as those dust masks that are specially designed to filter out microscopic particles.

2. **READ** the entire Owner's Manual. **LEARN** how to use the tool for its intended applications.

3. **GROUND ALL TOOLS.** If the tool is supplied with a 3 prong plug, it must be plugged into a 3-contact electrical receptacle. The 3rd prong is used to ground the tool and provide protection against accidental electric shock. **DO NOT** remove the 3rd prong. See Grounding Instructions on the following pages.

4. **AVOID A DANGEROUS WORKING ENVIRONMENT.** **DO NOT** use electrical tools in a damp environment or expose them to rain.

5. **DO NOT** use electrical tools in the presence of flammable liquids or gases.

6. **ALWAYS** keep the work area clean, well lit, and organized. **DO NOT** work in an environment with floor surfaces that are slippery from debris, grease, and wax.

7. **KEEP VISITORS AND CHILDREN AWAY. DO NOT** permit people to be in the immediate work area, especially when the electrical tool is operating.

8. **DO NOT FORCE THE TOOL** to perform an operation for which it was not designed. It will do a safer and higher quality job by only performing operations for which the tool was intended.

9. **WEAR PROPER CLOTHING. DO NOT** wear loose clothing, gloves, neckties, or jewelry. These items can get caught in the machine during operations and pull the operator into the moving parts. The user must wear a protective cover on their hair, if the hair is long, to prevent it from contacting any moving parts.

10. **CHILDPROOF THE WORKSHOP AREA** by removing switch keys, unplugging tools from the electrical receptacles, and using padlocks.

11. **ALWAYS UNPLUG THE TOOL FROM THE ELECTRICAL RECEPTACLE** when making adjustments, changing parts or performing any maintenance.

# SAFETY INSTRUCTIONS

**12. KEEP PROTECTIVE GUARDS IN PLACE AND IN WORKING ORDER.**

**13. AVOID ACCIDENTAL STARTING.** Make sure that the power switch is in the “OFF” position before plugging in the power cord to the electrical receptacle.

**14. REMOVE ALL MAINTENANCE TOOLS** from the immediate area prior to turning “ON” the machine.

**15. USE ONLY RECOMMENDED ACCESSORIES.** Use of incorrect or improper accessories could cause serious injury to the operator and cause damage to the tool. If in doubt, check the instruction manual that comes with that particular accessory.

**16. NEVER LEAVE A RUNNING TOOL UNATTENDED.** Turn the power switch to the “OFF” position. **DO NOT** leave the tool until it has come to a complete stop.

**17. DO NOT STAND ON A TOOL.** Serious injury could result if the tool tips over, or you accidentally contact the tool.

**18. DO NOT** store anything above or near the tool where anyone might try to stand on the tool to reach it.

**19. MAINTAIN YOUR BALANCE. DO NOT** extend yourself over the tool. Wear oil resistant rubber soled shoes. Keep floor clear of debris, grease, and wax.

**20. MAINTAIN TOOLS WITH CARE.** Always keep tools clean and in good working order. Keep all blades and tool bits sharp, dress grinding wheels and change other abrasive accessories when worn.

**21. EACH AND EVERY TIME, CHECK FOR DAMAGED PARTS PRIOR TO USING THE TOOL.** Carefully check all guards to see that they operate properly, are not damaged, and perform their intended functions. Check for alignment, binding or breaking of moving parts. A guard or other part that is damaged should be immediately repaired or replaced.

**22. DO NOT OPERATE TOOL WHILE TIRED, OR UNDER THE INFLUENCE OF DRUGS, MEDICATION OR ALCOHOL.**

**23. SECURE ALL WORK.** Use clamps or jigs to secure the work piece. This is safer than attempting to hold the work piece with your hands.

**24. STAY ALERT, WATCH WHAT YOU ARE DOING, AND USE COMMON SENSE WHEN OPERATING A POWER TOOL.**

A moment of inattention while operating power tools may result in serious personal injury.

**25. ALWAYS WEAR A DUST MASK TO PREVENT INHALING DANGEROUS DUST OR AIRBORNE PARTICLES,** including wood dust, crystalline silica dust and asbestos dust. Direct particles away from face and body. Always operate tool in well ventilated area and provide for proper dust removal. Use dust collection system wherever possible. Exposure to the dust may cause serious and permanent respiratory or other injury, including silicosis (a serious lung disease), cancer, and death. Avoid breathing the dust, and avoid prolonged contact with dust. Allowing dust to get into your mouth or eyes, or lay on your skin may promote absorption of harmful material. Always use properly fitting NIOSH/OSHA approved respiratory protection appropriate for the dust exposure, and wash exposed areas with soap and water.

**26. USE A PROPER EXTENSION CORD IN GOOD CONDITION.** When using an extension cord, be sure to use one heavy enough to carry the current your product will draw. The table on the following page shows the correct size to use depending on cord length and nameplate amperage rating. If in doubt, use the next heavier gauge. The smaller the gauge number, the larger diameter of the extension cord. If in doubt of the proper size of an extension cord, use a shorter and thicker cord. An undersized cord will cause a drop in line voltage resulting in a loss of power and overheating.  
**USE ONLY A 3-WIRE EXTENSION CORD THAT HAS A 3-PRONG GROUNDING PLUG AND A 3-POLE RECEPTACLE THAT ACCEPTS THE TOOL’S PLUG.**

**27. ADDITIONAL INFORMATION** regarding the safe and proper operation of this product is available from:

- Power Tool Institute  
1300 Summer Avenue  
Cleveland, OH 44115-2851  
[www.powertoolinstitute.org](http://www.powertoolinstitute.org)
- National Safety Council  
1121 Spring Lake Drive  
Itasca, IL 60143-3201  
[www.nsc.org](http://www.nsc.org)
- American National Standards Institute  
25 West 43rd Street, 4th Floor  
New York, NY 10036  
[www.ansi.org](http://www.ansi.org)
- ANSI 01.1 Safety Requirements for Woodworking Machines and the U.S. Department of Labor regulations  
[www.osha.gov](http://www.osha.gov)

**28. SAVE THESE INSTRUCTIONS.** Refer to them frequently and use them to instruct others.

# SAFETY INSTRUCTIONS

## ELECTRICAL SAFETY

**⚠ WARNING:** THIS TOOL MUST BE GROUNDED WHILE IN USE TO PROTECT THE OPERATOR FROM ELECTRIC SHOCK.

**IN THE EVENT OF A MALFUNCTION OR BREAKDOWN,** grounding provides the path of least resistance for electric current and reduces the risk of electric shock. This tool is equipped with an electric cord that has an equipment grounding conductor and requires a grounding plug (not included). The plug **MUST** be plugged into a matching electrical receptacle that is properly installed and grounded in accordance with **ALL** local codes and ordinances.

**DO NOT MODIFY ANY PLUG.** If it will not fit the electrical receptacle, have the proper electrical receptacle installed by a qualified electrician.

**IMPROPER ELECTRICAL CONNECTION** of the equipment grounding conductor can result in risk of electric shock. The conductor with the green insulation (with or without yellow stripes) is the equipment grounding conductor. **DO NOT** connect the equipment grounding conductor to a live terminal if repair or replacement of the electric cord or plug is necessary.

**CHECK** with a qualified electrician or service personnel if you do not completely understand the grounding instructions, or if you are not sure the tool is properly grounded when installing or replacing a plug.

**USE ONLY A 3-WIRE EXTENSION CORD THAT HAS THE PROPER TYPE OF A 3-PRONG GROUNDING PLUG THAT MATCHES THE MACHINE'S 3-PRONG PLUG AND ALSO THE 3-POLE RECEPTACLE THAT ACCEPTS THE TOOL'S PLUG.** \*

**REPLACE A DAMAGED OR WORN CORD IMMEDIATELY.**

This tool is intended for use on a circuit that has an electrical receptacle as shown in **FIGURE A**. It shows a 3-wire electrical plug and electrical receptacle that has a grounding conductor. If a properly grounded electrical receptacle is not available, an adapter as shown in **FIGURE B** can be used to temporarily connect this plug to a 2-contact ungrounded receptacle. The adapter has a rigid lug extending from it that **MUST** be connected to a permanent earth ground, such as a properly grounded receptacle box. **THIS ADAPTER IS PROHIBITED IN CANADA.**

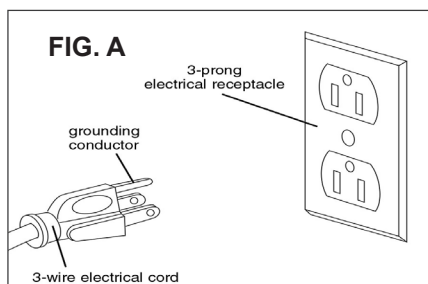

## EXTENSION CORDS

**⚠ WARNING:** THE USE OF AN EXTENSION CORD WITH THIS MACHINE IS NOT RECOMMENDED. For best power and safety, plug the machine directly into a dedicated, grounded electrical outlet that is within the supplied cord length of the machine.

If an extension cord needs to be used, it should only be for a limited operation of the machine. The extension cord should be as short as possible in length, and have a minimum gauge size of 14AWG.

**⚠ WARNING:** Check extension cords before each use. If damaged replace immediately. Never use a tool with a damaged cord, since touching the damaged area could cause electrical shock, resulting in serious injury.

Use a proper extension cord. Only use cords listed by Underwriters Laboratories (UL). Other extension cords can cause a drop in line voltage, resulting in a loss of power and overheating of tool. When operating a power tool outdoors, use an outdoor extension cord marked "W-A" or "W". These cords are rated for outdoor use and reduce the risk of electric shock.

### MINIMUM RECOMMENDED GAUGE FOR EXTENSION CORDS (AWG)

120 VOLT OPERATION ONLY				
	25' LONG	50' LONG	100' LONG	150' LONG
0 to 6 Amps	18 AWG	16 AWG	16 AWG	14 AWG
6 to 10 Amps	18 AWG	16 AWG	14 AWG	12 AWG
10 to 12 Amps	16 AWG	16 AWG	14 AWG	12 AWG

**⚠ WARNING:** Keep the extension cord clear of the working area. Position the cord so that it will not get caught on lumber, tools or other obstructions while you are working with your power tool.

\* Canadian electrical codes require extension cords to be certified SJT type or better.

\*\* The use of an adapter in Canada is not acceptable.

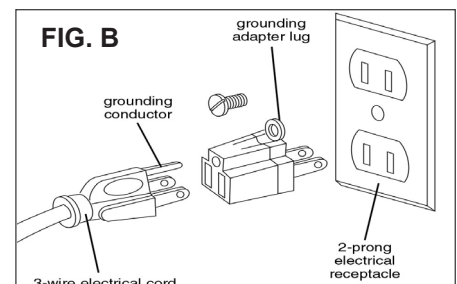

# SAFETY INSTRUCTIONS

## SPECIFIC SAFETY INSTRUCTIONS FOR DUST COLLECTORS

This machine is intended for the collection of chips, shavings and dust from the surfacing, cutting and sanding of natural wood, plywood, plastics and other man-made wood based composites. It is for collecting DRY materials only. Any other use not as specified, including modification of the machine or use of parts not tested and approved by the equipment manufacturer, can cause unforeseen damage and invalidate the warranty.

**ATTENTION:** Use of this dust collector still presents risks that cannot be eliminated by the manufacturer. Therefore, the user must be aware that wood working machines are dangerous if not used with care and all safety precautions are adhered to.

1. Do not operate this machine until you have read all of the following instructions.
2. Do not attempt to operate this machine until it is completely assembled.
3. Do not turn ON this machine if any pieces are missing or damaged.
4. If you are not familiar with the operation of the machine, obtain assistance from a qualified person.
5. It is highly recommended that this machine be placed on a sturdy vertical surface.
6. This machine must be properly grounded.
7. Always wear approved protective eye, hearing and respiratory protection when operating this machine.
8. Always make sure the power switch is in the OFF position prior to plugging in the machine.
9. Always make sure the power switch is in the OFF position and the machine is unplugged when doing any cleaning, assembly, setup operations, or when not in use.
10. DO NOT use the dust collector for collecting liquids, substances impregnated with liquids, metals, gasoline or potentially flammable or combustible substances.
11. DO NOT use the dust collector to dissipate fumes or smoke. NEVER pick up any material that is burning or smoking, such as cigarettes, matches or hot ashes.
12. DO NOT use the dust collector without a filter canister and dust collector bag securely in place.
13. DO NOT use the dust collector with unused intake ports uncapped. Always cover exposed intake ports.
14. Always wear a dust mask when cleaning or working near a dust collector.
15. Make sure all machine parts, hose connections and bags are securely tightened before operating the machine. Periodically check bags and hoses for rips or tears. If present, repair or replace immediately.
16. The use of any accessories or attachments not recommended may cause injury to you and damage your machine.
17. Never reach inside of a running machine. Always keep your hands, body parts and clothing clear of openings and moving parts such as impellers, fans and hose intake openings.
18. Do not clear any hose blockage while the machine is running. Stop the machine, unplug it from the power source, and then remove the blockage in the hose.
19. Do not expose the machine to rain or use in damp locations.
20. Keep these instructions for future reference.

**This owner's manual is not a teaching aid and is intended to show assembly, adjustments, and general use.**

### CALIFORNIA PROPOSITION 65 WARNING



**WARNING:** Drilling, sawing, sanding or machining wood products can expose you to wood dust, a substance known to the State of California to cause cancer. Avoid inhaling wood dust or use a dust mask or other safeguards for personal protection. For more information go to [www.P65Warnings.ca.gov/wood](http://www.P65Warnings.ca.gov/wood)

# CONTENTS OF PACKAGE

When unpacking, check to make sure the following parts are included. If any parts are missing or broken, please call RIKON Power Tools (877-884-5167) as soon as possible for replacements.

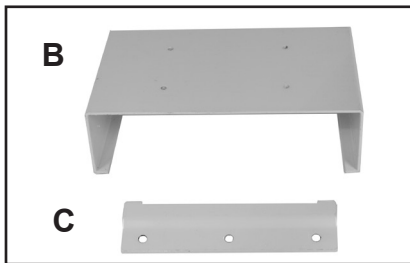
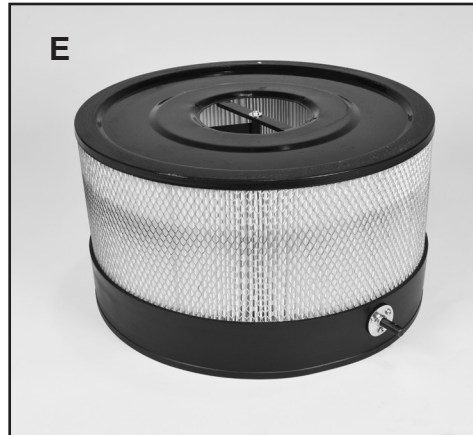

- Box 1 of 2
- A Motor & Fan Assembly
  - B Wall Mounting Bracket
  - C Motor Plate
  - D Manual ( not shown )

- Box 2 of 2
- E Filter Canister
  - F 4" 'Y' Dust Fitting with Cap
  - G Bag Strap Clamp
  - H Plastic Collection Bag
  - I Filter Cleaning Handle
- Hardware Pack:
- J Wrench 10/12mm
  - K Motor Mount Bolts 1/4-20x1/2" (4)
  - L Flange Bolts 1/4-20x3/4" (6)
  - M Hex Wrench 3mm

Parts Diagram and Parts List are listed on Pages 12 and 13.

- Needed For Setup**
- Tape Measure
  - Drill & Drill Bits
  - Phillips Screwdriver
  - Level
  - Fasteners
  - Safety Glasses & Respirator
  - 4" Dust Hose
  - Hose Clamps

Model #60-101 Wall Mounted 1HP Portable Dust Collector is shipped complete in two boxes.

## Unpacking and Clean-up

1. Carefully remove all contents from the shipping carton. Compare the contents with the list of contents to make sure that all of the items are accounted for, before discarding any packing material. Place parts on a protected surface for easy identification and assembly. If any parts are missing or broken, please call RIKON Customer Service (877-884-5167) as soon as possible for replacements. DO NOT turn your machine ON if any of these items are missing. You may cause injury to yourself or damage to the machine.
2. Report any shipping damage to your local distributor. Take photographs for any possible insurance claims.
3. Clean any rust protected surfaces with ordinary house hold type grease or spot remover. Do not use; gasoline, paint thinner, mineral spirits, etc. These may damage painted surfaces.
4. Set packing material and shipping carton aside. Do not discard until the machine has been set up and is running properly.

# ASSEMBLY

**NOTE:** The parts listed in the instructions refer to either the Contents of Package on page 7, or the Parts Diagram & Parts List on pages 12 & 13.

**⚠ WARNING** THE MACHINE MUST NOT BE PLUGGED IN AND THE POWER SWITCH MUST BE IN THE OFF POSITION UNTIL ASSEMBLY IS COMPLETE.

## INSTALL THE MOTOR PLATE TO THE MOTOR BRACKET

Locate the following parts:

- Motor & Fan Assembly (A, Parts Diagram #34)
- Motor Plate (C, #11)
- 4 Motor Mount Bolts 1/4-20x1/2" (K, #25)
- Wrench 10/12mm (J)

**NOTE:** Before assembly, screw the bolts into the threaded holes in the motor plate. This will 'clean out' any paint that may be left on the threads from the painting process, and will make the final assembly of parts easier.

1. Assemble the Motor Plate (A) to the Motor Bracket (C) with the 4 Bolts (K). Figure 1.

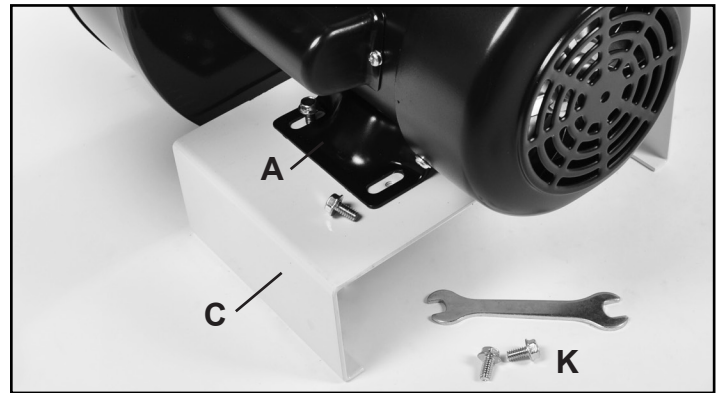

FIG. 1

## INSTALL THE FILTER CANISTER TO THE MOTOR ASSEMBLY

Locate the following parts:

- Motor & Fan Assembly (A, Parts List #34)
- Filter Canister (E, #1)
- 6 Flange Bolts 1/4-20x3/4" (L, #27)
- Wrench 10/12mm (J)

1. Position the Motor & Fan Assembly (A) onto the Filter Canister (E). Figure 2.

**NOTE:** The motor assembly is heavy and tilts easily, so a second set of hands is recommended to help hold the motor during its assembly to the canister.

2. Align the Canister so that the Spindle (#4) to mount the Filter Cleaning Handle (G, #13) is positioned to the right, near the motor area. This will position the handle away from the walls for unrestricted operation.

3. Align the 6 holes in the motor assembly's bottom flange with the 6 holes in the top of the canister and assemble the parts together with the 6 Bolts (L, #27). Figure 2.

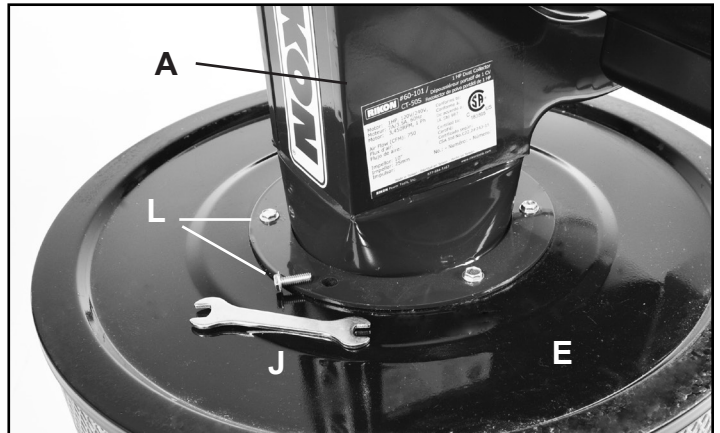

FIG. 2

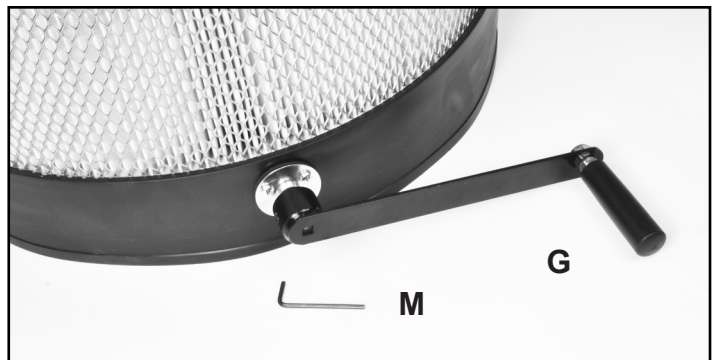

FIG. 3

## INSTALL THE FILTER CANISTER HANDLE

Locate the following parts:

- Filter Cleaning Handle (G, Parts List #13)
- Hex Wrench 3mm (M)

1. Assemble the Filter Cleaning Handle (G) onto the canister's Spindle (#4) and secure it in place with the Hex Bolt (#20) using the 3mm hex wrench provided. Figure 3.



# ASSEMBLY

## MOUNTING THE 'Y' INLET

Locate the following parts:

- 4" 'Y' Dust Fitting with Cap (F, Parts List #46,47)
- Phillips Screw (#45)
- Phillips Screwdriver (not included)

1. Slide the 'Y' Inlet (#46) over the large 5" opening on the fan housing, so that the mounting hole aligns.

2. Secure the 'Y' inlet in place with the supplied Phillips head screw (#45). Figure 4.

3. The 'Y' Inlet has two 4" hose connections for use with two woodworking machines. A plastic Cap (#47) is included to plug one of the 4" inlets if only one machine hose is hooked up for dust collection.

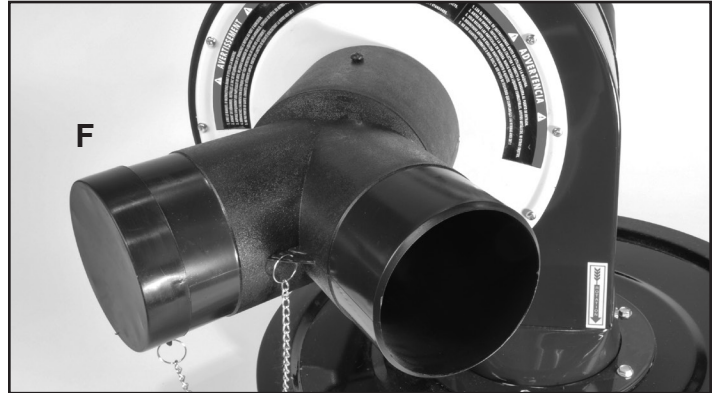

FIG. 4

## INSTALL THE WALL MOUNTING BRACKET

Locate the following parts:

- Wall Mounting Bracket (B, Parts List #12)
- Lag bolts, screws, molleys & tools (not included)
- Level, pencil, drill, wrenches or screwdriver

1. Position the Mounting Bracket (#12) on a sturdy wall at a height for the dust collector's bag to freely hang down without harm, about 50-65" from the floor. Also position the bracket ample room away from any side walls so that there is plenty of room for operating the canister handle or dealing with the dust hoses.

The Dust Collector should be near an electrical outlet so an extension cord is not used, and near a machine(s) so a long dust hose is not needed, which can reduce the suction efficiency of the dust collector.

2. Once the position of the bracket on a wall is determined, use a pencil to mark the wall with the locations of the 3 holes in the mounting plate. If possible, locate the center hole where there is a stud. Mount the bracket. Figure 5.

**NOTE:** For solid, plywood or masonry walls, fasteners can be used to directly attach the plate to the wall. For wallboard, the use of molleys are recommended.

## MOUNTING THE COLLECTOR ON THE WALL

Once the mounting bracket (B) is installed, the dust collector can be hung on the bracket. The base of the Motor Plate (C, #11) will fit into the recess on the bracket to secure the collector in place. Figure 6 & 7.

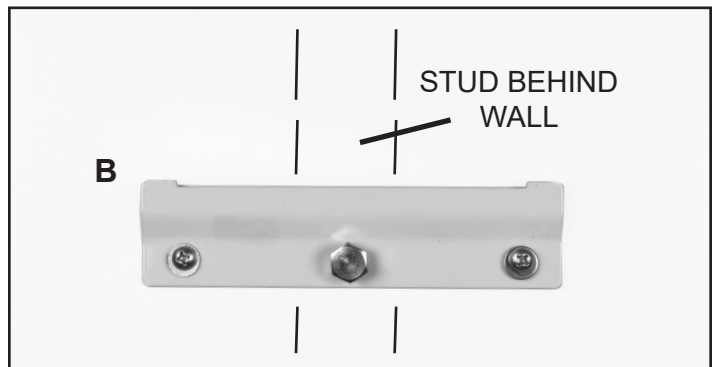

FIG. 5



FIG. 6



FIG. 7

# ASSEMBLY

## INSTALL THE PLASTIC DUST BAG

1. Install the lower, clear plastic collection bag (#29) onto the bottom rim of the Filter Canister. Temporarily secure it in place with some adhesive tape (masking, duct, etc), magnets or small binder clips.
2. Install the Strap Clamp (#16) around the canister and over the plastic bag. Lock it in place with the strap clamp. Engage the catch end of the strap with the clasp in the appropriate slot to ensure a tight fit, and press the lever with the palm of your hand to lock the clamp. Figure 8.

**NOTE:** To release the clamp, lift up on the lever. If the lever is hard to disengage, simply use a flat head screwdriver to pry the lever upwards.

## INSTALL THE DUST HOSE

**NOTE:** Dust hoses and hose clamps are NOT included with the machine. Obtaining these accessories are the responsibility of the user. Please visit your local machine dealer for dust collection supplies.

The 60-101 Dust Collector includes a 5" diameter dust hose inlet on its fan cover. 5" dust hoses can be clamped directly onto this large inlet. See Figure 9.

For use with 4" dust hose, a 'Y' Fitting (#46) with dual 4" inlets is supplied with the machine that connects onto the 5" inlet. This permits the user to hook up 1 or 2 machines to the dust collector. If only one 4" inlet is to be used, a special Cap (# 47, A) is supplied to cover the unused 4" inlet. This allows the machine's full suction power to be channeled to the one open inlet. Figure 10.

For using either 5" or 4" hoses, installing them onto the dust collector fitting(s) and your woodworking machine is the same process. 4" hose shown in the following example. Figure 11.

1. Slip a hose clamp (B) over both ends of the hose.
2. Place one end of the hose over the 4" inlet on the collector's fan housing cover (B) and tighten the hose clamp with a slotted screwdriver or wrench. Figure 11.
3. The other end of the hose can be installed directly to the dust port onto one of your shop woodworking machines (bandsaw, sander, planer, etc.). Tighten the hose in place with the hose clamp.

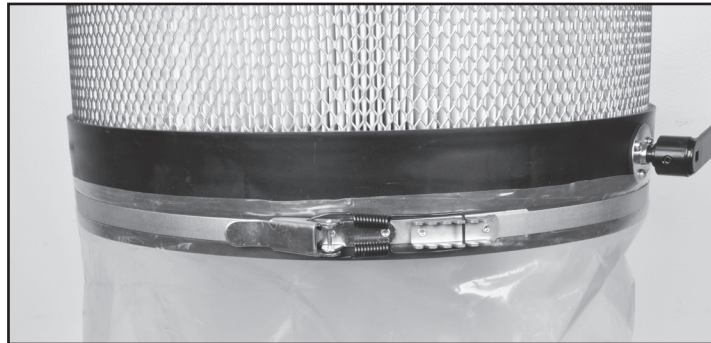

FIG. 8

**WARNING** THE MACHINE MUST NOT BE PLUGGED IN AND THE POWER SWITCH MUST BE IN THE OFF POSITION UNTIL ASSEMBLY IS COMPLETE.



FIG. 9

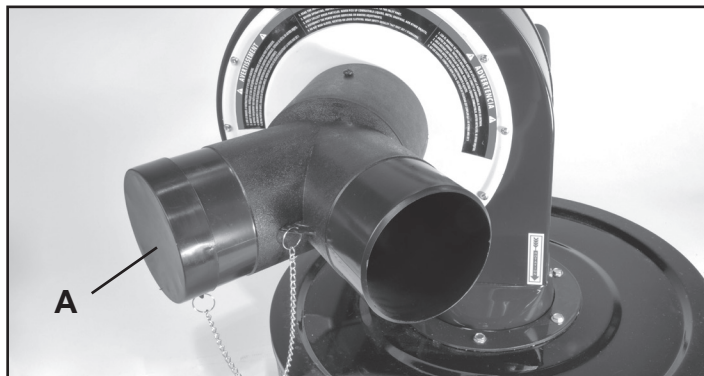

FIG. 10



FIG. 11

## OPERATION

### ON/OFF LOCKING SAFETY SWITCH

**CAUTION:** Make sure that the On/Off locking switch is in the “Off” position before plugging the dust collector into a power source.

The On/Off Locking Switch has a center Safety Key (A) that can be used to prevent unauthorized use of the dust collector. The switch needs to have the center key inserted before the machine can be used. Figure 12.

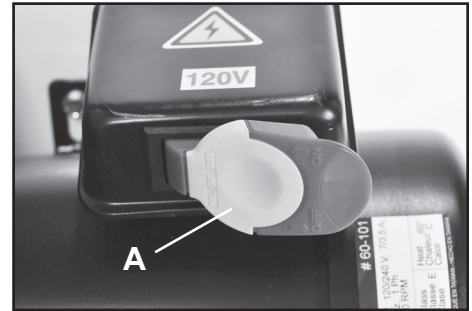

FIG. 12

## DUST HAZARDS AND SAFETY

### EMPTYING & CLEANING THE DUST COLLECTOR

**CAUTION:** Make sure the dust collector is unplugged before cleaning or servicing. Always wear a dust mask or respirator while emptying the collector bags or cleaning the dust collector. Please refer to the California Proposition 65 warning on page 6 of this manual regarding hazards from exposure to wood dust. For more detailed information visit [www.P65Warnings.ca.gov/wood](http://www.P65Warnings.ca.gov/wood).

### GROUNDING THE DUCT WORK

**NOTE:** For permanent dust collector set-ups, the following instructions are recommended. For the occasional use of any dust collector, care must none-the-less be taken to keep the hose and bag clean.

Dust particles moving through flexible or rigid plastic duct work can cause static electricity build-up. The duct work must be properly grounded to ensure that static discharge does not ignite fine dust particles causing an explosion or fire.

To properly ground *plastic* duct work, simply run a small gauge bare copper wire through the ducting and have it emerge from the hose at the dust collector and at each dust producing machine. The bare copper wire should be bonded to the metal shell of each machine by means of a metal screw. The screw must be threaded into the metal shell to ensure a good connection.

The grounding of *metal* duct work is similar, the only difference is that there is no need to run the bare copper wire inside the ducting. It can be wrapped along the out side of the ducting and should be bonded to each machine as described above.

## ACCESSORIES



### 60-904 CLEAR PLASTIC BAGS - PACK OF 5

Clear plastic lower bags for the collection and disposal of the dust and debris from the dust collector. Bags fit the 60-101 Dust Collector Canister's 19-5/8" (500mm) diameter. Bag capacity approx 1.5 cu/ft.

To order replacement parts or accessories for the 60-101 Dust Collector or other RIKON machines, contact your local RIKON Distributor, or visit the RIKON website at [www.rikontools.com](http://www.rikontools.com).

# PARTS DIAGRAM

## 60-101 Wall Mounted DUST COLLECTOR

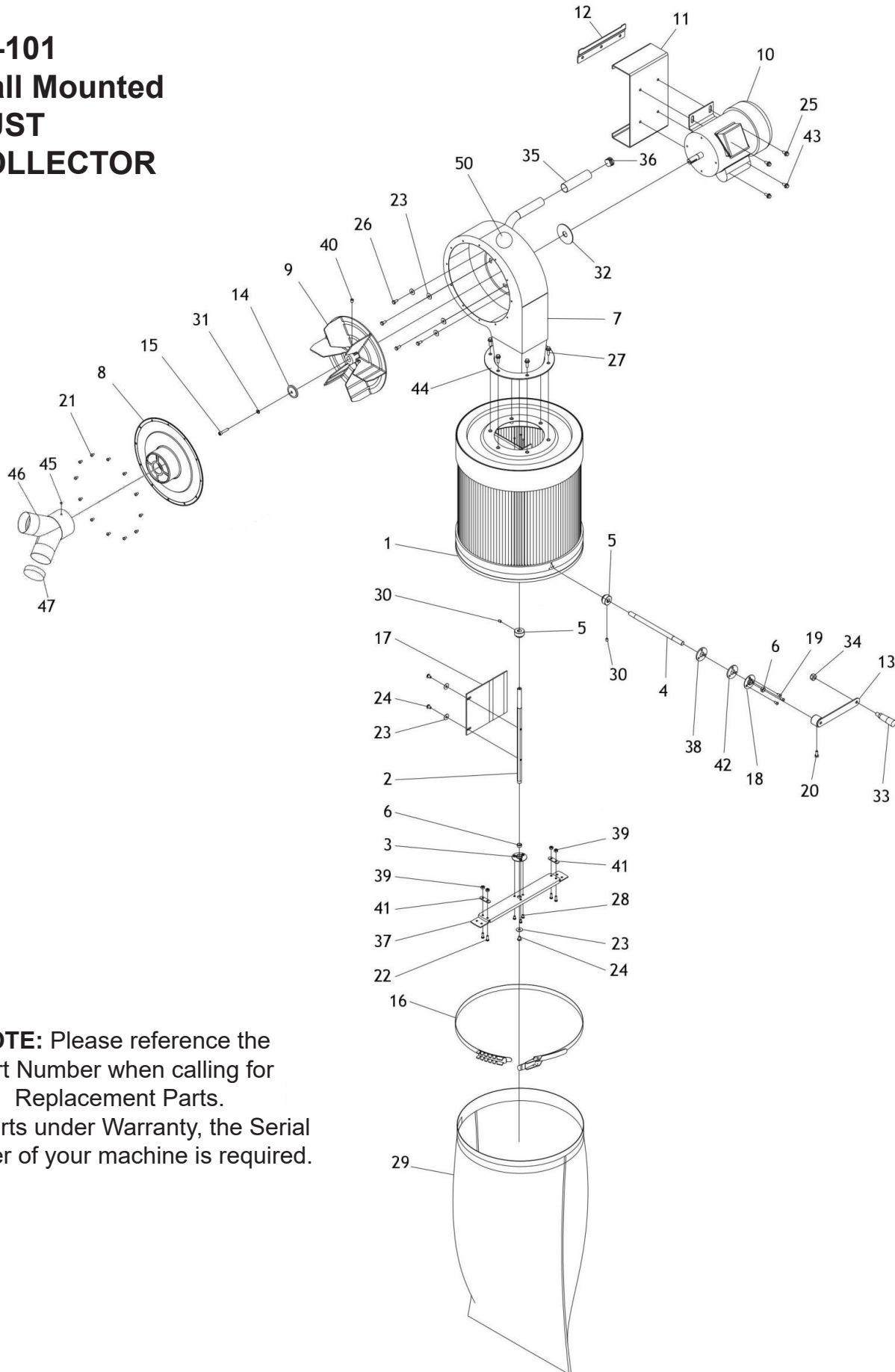

**NOTE:** Please reference the Part Number when calling for Replacement Parts.  
For Parts under Warranty, the Serial Number of your machine is required.

## PARTS LIST

KEY NO.	DESCRIPTION	QTY.	PART NO.
1	Canister Filter	1	P60-101-1
2	Main Spindle	1	P60-101-2
3	Bearing Fixing Plate	1	P60-101-3
4	Connecting Spindle	1	P60-101-4
5	Bevel Gears	2	P60-101-5
6	Self-lubricating Bearings	3	P60-101-6
7	Main Housing	1	P60-101-7
8	Inlet Cover	1	P60-101-8
9	Aluminum Impeller 10"	1	P60-101-9
10	Motor	1	P60-101-10
11	Motor Plate	1	P60-101-11
12	Wall Mount Bracket	1	P60-101-12
13	Handle	1	P60-101-13
14	Impeller Washer 6 mm	1	P60-101-14
15	Cap Screw M6×30 LH	1	P60-101-15
16	Belt Clamp	1	P60-101-16
17	Flapper	1	P60-101-17
18	Bearing Fixing Plate	1	P60-101-18
19	Phillip HD Screws M5×10 mm	3	P60-101-19
20	Hex Bolt M6×16 mm	1	P60-101-20
21	Phillip HD Screws M5×10 mm	12	P60-101-21
22	Phillip HD Screws M5×15 mm	4	P60-101-22
23	Flat Washers 1/4"×18	4	P60-101-23
24	Phillip HD Screws M6×12 mm	4	P60-101-24
25	Flange Screws 1/4-20×1/2"	4	P60-101-25
26	Hex Bolts 1/4-20×1/2"	4	P60-101-26
27	Flange Screws 1/4-20×3/4"	6	P60-101-27
28	Phillip HD Screws M5×8 mm	3	P60-101-28
29	Plastic Dust Bag 58cm×76cm flat	1	P60-101-29
30	Set Screws 1/4-20×5/16"	2	P60-101-30
31	Spring Washer 1/4"	1	P60-101-31
32	Motor Gasket	1	P60-101-32
33	Hand Wheel M10×14	1	P60-101-33
34	Locking Nut M10	1	P60-101-34
35	Handle Cover 1"×4"	1	P60-101-35
36	End Cap 1"	1	P60-101-36
37	Spindle Plate	1	P60-101-37
38	Bearing Fixing Plate (Special)	1	P60-101-38
39	Hex Nuts M5	4	P60-101-39
40	Set Screw 5/16-18×5/16"	1	P60-101-40
41	Mounting Plates	2	P60-101-41
42	Rubber Gaskets	2	P60-101-42
43	Flange Bolts 1/4"×1/2"	4	P60-101-43
44	Canister Gasket	1	P60-101-44
45	Phillip HD Screw 3/8"	1	P60-101-45
46	Y-Inlet 5"×4" (×2)	1	P60-101-46
47	Inlet Cap 4"	1	P60-101-47

60-101 Wall Mounted DUST COLLECTOR

# WIRING DIAGRAM

T1 = Black  
T2 = Gray  
T3 = Red  
T4 = Yellow

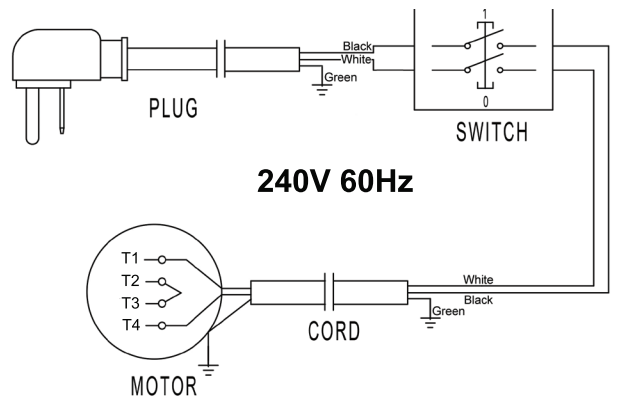
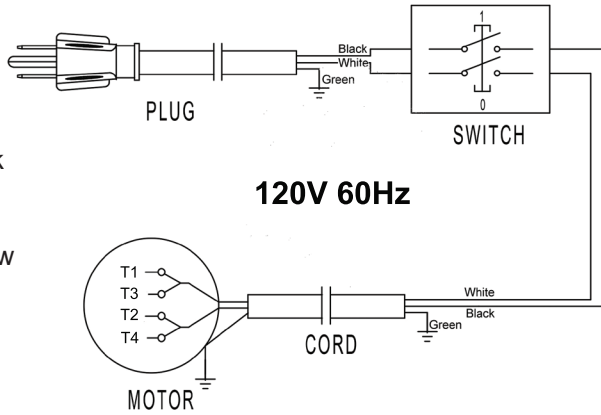

**⚠ WARNING:**

This machine must be grounded. Replacement of the power supply cable should only be done by a qualified electrician. See page 5 for additional electrical information.

# TROUBLESHOOTING

PROBLEM	POSSIBLE CAUSE	SOLUTION
Motor does not start	<ol style="list-style-type: none"> <li>1. Machine not plugged in.</li> <li>2. Power switch in 'OFF' position.</li> <li>3. Power switch or cord is faulty.</li> <li>4. Fuse or circuit breaker are open.</li> <li>5. Low line voltage.</li> <li>6. Defective motor capacitor.</li> <li>7. Motor does not work.</li> </ol>	<ol style="list-style-type: none"> <li>1. Plug cord into electrical outlet.</li> <li>2. Lift switch to 'ON' position. The safety key must be in place. See page 11.</li> <li>3. Replace switch or cord.</li> <li>4. Correct overloaded electrical circuit.</li> <li>5. Correct low line voltage condition.</li> <li>6. Replace motor capacitor.</li> <li>7. Repair or replace the motor.</li> </ol>
Motor runs hot	<ol style="list-style-type: none"> <li>1. Restricted air flow due to dirty filter or blockage in the hoses.</li> <li>2. Motor overloaded.</li> <li>3. Extension cord is used.</li> <li>4. Machine used for extended time.</li> <li>5. Poor air flow in work area.</li> </ol>	<ol style="list-style-type: none"> <li>1. Clean filter and hoses for maximum air flow through the system.</li> <li>2. Reduce load on the motor.</li> <li>3. Do not use an extension cord. Plug the collector directly into an outlet.</li> <li>4. Reduce run time of machine.</li> <li>5. Reposition machine for better air flow.</li> </ol>
Motor stalls or does not have full power	<ol style="list-style-type: none"> <li>1. Incorrect line voltage.</li> <li>2. Motor capacitor has failed.</li> <li>3. Extension cord is being used.</li> <li>4. Impeller is clogged with debris.</li> </ol>	<ol style="list-style-type: none"> <li>1. Have qualified electrician check circuit for proper line voltage.</li> <li>2. Replace motor capacitor.</li> <li>3. Do not use an extension cord. Plug the collector directly into an outlet.</li> <li>4. Clean debris from blocked impeller.</li> </ol>
Reduction of dust collection suction power	<ol style="list-style-type: none"> <li>1. Malfunction of the filter cleaning system.</li> <li>2. Plugged hose lines.</li> <li>3. Retaining of dust in the collector due to low density.</li> <li>4. Wetting of filter.</li> <li>5. Filter is dirty or permeability of the cloth has increased.</li> </ol>	<ol style="list-style-type: none"> <li>1. Check all system components.</li> <li>2. Check and clean inlets and hoses for obstructions.</li> <li>3. Clean or replace filter and check all connections for leakage.</li> <li>4. Control intake of moisture. Dry wet filter.</li> <li>5. Clean or replace filter.</li> </ol>
Loud or unusual noises from motor or fan	<ol style="list-style-type: none"> <li>1. Motor, fan housing, base or parts of the frame are loose.</li> <li>2. Impeller fan is rubbing the housing.</li> <li>3. Motor bearings are loud.</li> <li>4. Impeller fan is loose, unbalanced, or damaged.</li> </ol>	<ol style="list-style-type: none"> <li>1. Inspect and tighten all parts or replace as needed.</li> <li>2. Check position of the fan and adjust or replace any loose/damaged parts.</li> <li>3. Replace worn bearings.</li> <li>4. Secure fan on motor shaft, and replace if any damage is found.</li> </ol>

## MAINTENANCE

**⚠ WARNING:** Turn the power switch “OFF” and disconnect the plug from the outlet prior to adjusting or maintaining the machine. DO NOT attempt to repair or maintain the electrical components of the motor. Contact a qualified service technician for this type of maintenance.

1. Before each use:

- Check the power cord and plug for any wear or damage.
- Check for any loose screws or hardware.
- Check the area to make sure it is clear of any misplaced tools, lumber, cleaning supplies, etc. that could hamper the safe operation of the machines being used.

2. To avoid a build-up of wood dust, regularly clean all parts of your machines using a soft cloth, brush or compressed air. A general cleaning should be done after every use to avoid future problems and ensure the machines are in ready condition for the next time that they are used.

**WARNING:** If blowing sawdust, wear proper eye protection to prevent debris from blowing into eyes.

3. Check the duct work and hoses to make sure that there are no loose connections. Making sure that they are in proper operating condition will ensure that the dust collection will be the best possible.

4. Clean the filtering canister on a regular basis to prevent the build-up of dust for better dust collection and air filtration. Check for abrasion, tears or damage.

**WARNING:** Always wear a dust mask or respirator while emptying the collector bags or cleaning the dust collector. Please refer to the California Proposition 65 warning on page 6 of this manual regarding hazards from exposure to wood dust. For more detailed information visit [www.P65Warnings.ca.gov/wood](http://www.P65Warnings.ca.gov/wood) or [www.oehha.ca.gov](http://www.oehha.ca.gov).

5. The motor does not need any maintenance as it is equipped with sealed, lubricated ball bearings.

## WARRANTY

**RIKON**  
POWER TOOLS®

### 5-Year Limited Warranty

RIKON Power Tools Inc. (“Seller”) warrants to only the original retail consumer/purchaser of our products that each product be free from defects in materials and workmanship for a period of five (5) years from the date the product was purchased at retail. This warranty may not be transferred.

This warranty does not apply to defects due directly or indirectly to misuse, abuse, negligence, accidents, repairs, alterations, lack of maintenance or normal wear and tear. Under no circumstances will Seller be liable for incidental or consequential damages resulting from defective products. All other warranties, expressed or implied, whether of merchantability, fitness for purpose, or otherwise are expressly disclaimed by Seller. This five-year warranty does not cover products used for commercial, industrial or educational purposes. The warranty term for these claims will be limited to a two-year period.

This limited warranty does not apply to accessory items such as blades, drill bits, sanding discs, grinding wheels, belts, guide bearings and other related items.

Seller shall in no event be liable for death, injuries to persons or property, or for incidental, contingent, special, or consequential damages arising from the use of our products.

To take advantage of this warranty, proof of purchase documentation must be provided which has the date of purchase and an explanation of the complaint.

The Seller reserves the right to effect at any time, without prior notice, those alterations to parts, fittings, and accessory equipment which they may deem necessary for any reason whatsoever.

To register your machine online, visit RIKON at [www.rikontools.com/warranty](http://www.rikontools.com/warranty)

To take advantage of this warranty, or if you have any questions, please contact us at 877-884-5167 or email [warranty@rikontools.com](mailto:warranty@rikontools.com)



**For more information:  
16 Progress Road  
Billerica, MA 01821**

**877-884-5167 / 978-528-5380  
techsupport@rikontools.com**



LINK TO RIKON WEBSITE