

8" Jointer with Helical Cutterhead



Operator's Manual

Record the serial number and date of purchase in your manual for future reference.

Serial Number: _____ Date of purchase: _____

For technical support or parts questions, email techsupport@rikontools.com or call toll free at (877)884-5167

TABLE OF CONTENTS

Specifications.....	2
Safety Instructions	3 - 6
Getting To Know Your Machine	7
Contents of Package	7 - 8
Installation	8
Assembly	9 - 13
Operation	13 - 15
Adjustments.....	16 - 19
Maintenance	20
Electricals & Wiring Diagram	5 & 20
Troubleshooting	21
Parts Diagrams & Parts Lists	22 - 26
Accessories	27
Warranty	27

SPECIFICATIONS

Motor	2 HP, 220V, 60Hz, 12A, PH1, AC
Motor Speed (no load).....	3,450 RPM
Cutterhead Diameter	3"
Cutterhead Speed	5,500 RPM
Number of Carbide Knife Inserts, 4-sided.....	40
Knife Insert Size (LxWxT)	0.55" x 0.55" x 0.078" (14mm x 14mm x 2mm)
Number of Cutterhead Insert Rows	4
Maximum Depth of Cut	1/8"
Maximum Cutting Width	8"
Minimum Length of Stock	12"
Minimum Width of Stock	3/4"
Minimum Thickness of Stock	1/2"
Table Size (2) (LxW)	31-3/4" x 9-3/8"
Overall Table Size (LxW)	73-1/2" x 9-3/8"
Fence Size (LxW)	35" x 4-7/8"
Fence Tilt	-45° to 135°
Dust Port (O.D.).....	4"
Dust Collection Minimum CFM	500
Noise Level (no load)	≤ 100 dB
Overall Size (LxWxH).....	73-1/2" x 32" x 46"
Base Size (LxW).....	30" x 17-1/2"
Net Weight	434 lbs

NOTE: The specifications, photographs, drawings and information in this manual represent the current model when the manual was prepared. Changes and improvements may be made at any time, with no obligation on the part of Rikon Power Tools, Inc. to modify previously delivered units. Reasonable care has been taken to ensure that the information in this manual is correct, to provide you with the guidelines for the proper safety, assembly and operation of this machine.

SAFETY INSTRUCTIONS

IMPORTANT! Safety is the single most important consideration in the operation of this equipment. **The following instructions must be followed at all times.** Failure to follow all instructions listed below may result in electric shock, fire, and/or serious personal injury.

There are certain applications for which this tool was designed. We strongly recommend that this tool not be modified and/or used for any other application other than that for which it was designed. If you have any questions about its application, do not use the tool until you have contacted us and we have advised you.

SAFETY SYMBOLS



SAFETY ALERT SYMBOL: Indicates DANGER, WARNING, or CAUTION. This symbol may be used in conjunction with other symbols or pictographs.



Indicates an imminently hazardous situation, which, if not avoided, could result in death or serious injury.



Indicates a potentially hazardous situation, which, if not avoided, could result in death or serious injury.



Indicates a potentially hazardous situation, which, if not avoided, could result in minor or moderate injury.

NOTICE: Shown without Safety Alert Symbol indicates a situation that may result in property damage.

GENERAL SAFETY

KNOW YOUR POWER TOOL. Read the owner's manual carefully. Learn the tool's applications, work capabilities, and its specific potential hazards.

BEFORE USING YOUR MACHINE

To avoid serious injury and damage to the tool, read and follow all of the Safety and Operating Instructions before operating the machine.

1. Some dust created by using power tools contains chemicals known to the State of California to cause cancer, birth defects, or other reproductive harm.

Some examples of these chemicals are:

- Lead from lead-based paints.
- Crystalline silica from bricks, cement, and other masonry products.
- Arsenic and chromium from chemically treated lumber.

Your risk from these exposures varies, depending on how often you do this type of work. To reduce your exposure to these chemicals: work in a well ventilated area and work with approved safety equipment, such as those dust masks that are specially designed to filter out microscopic particles.

2. **READ** the entire Owner's Manual. **LEARN** how to use the tool for its intended applications.

3. **GROUND ALL TOOLS.** If the tool is supplied with a 3 prong plug, it must be plugged into a 3-contact electrical receptacle. The 3rd prong is used to ground the tool and provide protection against accidental electric shock. **DO NOT** remove the 3rd prong. See Grounding Instructions on the following pages.

4. **AVOID A DANGEROUS WORKING ENVIRONMENT.** **DO NOT** use electrical tools in a damp environment or expose them to rain.

5. **DO NOT** use electrical tools in the presence of flammable liquids or gases.

6. **ALWAYS** keep the work area clean, well lit, and organized. **DO NOT** work in an environment with floor surfaces that are slippery from debris, grease, and wax.

7. **KEEP VISITORS AND CHILDREN AWAY. DO NOT** permit people to be in the immediate work area, especially when the electrical tool is operating.

8. **DO NOT FORCE THE TOOL** to perform an operation for which it was not designed. It will do a safer and higher quality job by only performing operations for which the tool was intended.

9. **WEAR PROPER CLOTHING. DO NOT** wear loose clothing, gloves, neckties, or jewelry. These items can get caught in the machine during operations and pull the operator into the moving parts. The user must wear a protective cover on their hair, if the hair is long, to prevent it from contacting any moving parts.

10. **CHILDPROOF THE WORKSHOP AREA** by removing switch keys, unplugging tools from the electrical receptacles, and using padlocks.

11. **ALWAYS UNPLUG THE TOOL FROM THE ELECTRICAL RECEPTACLE** when making adjustments, changing parts or performing any maintenance.

SAFETY INSTRUCTIONS

12. KEEP PROTECTIVE GUARDS IN PLACE AND IN WORKING ORDER.

13. AVOID ACCIDENTAL STARTING. Make sure that the power switch is in the “OFF” position before plugging in the power cord to the electrical receptacle.

14. REMOVE ALL MAINTENANCE TOOLS from the immediate area prior to turning “ON” the machine.

15. USE ONLY RECOMMENDED ACCESSORIES. Use of incorrect or improper accessories could cause serious injury to the operator and cause damage to the tool. If in doubt, check the instruction manual that comes with that particular accessory.

16. NEVER LEAVE A RUNNING TOOL UNATTENDED. Turn the power switch to the “OFF” position. **DO NOT** leave the tool until it has come to a complete stop.

17. DO NOT STAND ON A TOOL. Serious injury could result if the tool tips over, or you accidentally contact the tool.

18. DO NOT store anything above or near the tool where anyone might try to stand on the tool to reach it.

19. MAINTAIN YOUR BALANCE. DO NOT extend yourself over the tool. Wear oil resistant rubber soled shoes. Keep floor clear of debris, grease, and wax.

20. MAINTAIN TOOLS WITH CARE. Always keep tools clean and in good working order. Keep all blades and tool bits sharp, dress grinding wheels and change other abrasive accessories when worn.

21. EACH AND EVERY TIME, CHECK FOR DAMAGED PARTS PRIOR TO USING THE TOOL. Carefully check all guards to see that they operate properly, are not damaged, and perform their intended functions. Check for alignment, binding or breaking of moving parts. A guard or other part that is damaged should be immediately repaired or replaced.

22. DO NOT OPERATE TOOL WHILE TIRED, OR UNDER THE INFLUENCE OF DRUGS, MEDICATION OR ALCOHOL.

23. SECURE ALL WORK. Use clamps or jigs to secure the work piece. This is safer than attempting to hold the work piece with your hands.

24. STAY ALERT, WATCH WHAT YOU ARE DOING, AND USE COMMON SENSE WHEN OPERATING A POWER TOOL.

A moment of inattention while operating power tools may result in serious personal injury.

25. ALWAYS WEAR A DUST MASK TO PREVENT INHALING DANGEROUS DUST OR AIRBORNE PARTICLES, including wood dust, crystalline silica dust and asbestos dust. Direct particles away from face and body. Always operate tool in well ventilated area and provide for proper dust removal. Use dust collection system wherever possible. Exposure to the dust may cause serious and permanent respiratory or other injury, including silicosis (a serious lung disease), cancer, and death. Avoid breathing the dust, and avoid prolonged contact with dust. Allowing dust to get into your mouth or eyes, or lay on your skin may promote absorption of harmful material. Always use properly fitting NIOSH/OSHA approved respiratory protection appropriate for the dust exposure, and wash exposed areas with soap and water.

26. USE A PROPER EXTENSION CORD IN GOOD CONDITION. When using an extension cord, be sure to use one heavy enough to carry the current your product will draw. The table on the following page shows the correct size to use depending on cord length and nameplate amperage rating. If in doubt, use the next heavier gauge. The smaller the gauge number, the larger diameter of the extension cord. If in doubt of the proper size of an extension cord, use a shorter and thicker cord. An undersized cord will cause a drop in line voltage resulting in a loss of power and overheating.
USE ONLY A 3-WIRE EXTENSION CORD THAT HAS A 3-PRONG GROUNDING PLUG AND A 3-POLE RECEPTACLE THAT ACCEPTS THE TOOL’S PLUG.

27. ADDITIONAL INFORMATION regarding the safe and proper operation of this product is available from:

- Power Tool Institute
1300 Summer Avenue
Cleveland, OH 44115-2851
www.powertoolinstitute.org
- National Safety Council
1121 Spring Lake Drive
Itasca, IL 60143-3201
www.nsc.org
- American National Standards Institute
25 West 43rd Street, 4th Floor
New York, NY 10036
www.ansi.org
- ANSI 01.1 Safety Requirements for Woodworking Machines and the U.S. Department of Labor regulations
www.osha.gov

28. SAVE THESE INSTRUCTIONS. Refer to them frequently and use them to instruct others.

SAFETY INSTRUCTIONS

ELECTRICAL SAFETY

⚠ WARNING: THIS TOOL IS PRE-WIRED FOR 220V CIRCUITS, AND MUST BE GROUNDED WHILE IN USE TO PROTECT THE OPERATOR FROM ELECTRIC SHOCK.

IN THE EVENT OF A MALFUNCTION OR BREAKDOWN, grounding provides the path of least resistance for electric current and reduces the risk of electric shock. This tool is equipped with an electric cord that has an equipment grounding conductor and requires a grounding plug (not included). The plug **MUST** be plugged into a matching electrical receptacle that is properly installed and grounded in accordance with **ALL** local codes and ordinances.

DO NOT MODIFY ANY PLUG. If it will not fit the electrical receptacle, have the proper electrical receptacle installed by a qualified electrician.

IMPROPER ELECTRICAL CONNECTION of the equipment grounding conductor can result in risk of electric shock. The conductor with the green insulation (with or without yellow stripes) is the equipment grounding conductor. **DO NOT** connect the equipment grounding conductor to a live terminal if repair or replacement of the electric cord or plug is necessary.

CHECK with a qualified electrician or service personnel if you do not completely understand the grounding instructions, or if you are not sure the tool is properly grounded when installing or replacing a plug.

USE ONLY A 3-WIRE EXTENSION CORD THAT HAS THE PROPER TYPE OF A 3-PRONG GROUNDING PLUG THAT MATCHES THE MACHINE'S 3-PRONG PLUG AND ALSO THE 3-POLE RECEPTACLE THAT ACCEPTS THE TOOL'S PLUG. * See Figure A.

REPLACE A DAMAGED OR WORN CORD IMMEDIATELY.

This tool is intended for use on a circuit that has a 220 volt electrical receptacle. **FIGURE A** shows the type of the 220v, 3-wire electrical plug and electrical receptacle that has a grounding conductor that is required if the motor wiring is changed. See page 20.

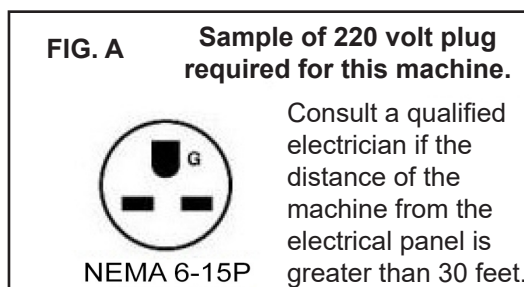

EXTENSION CORDS

⚠ WARNING: THE USE OF AN EXTENSION CORD WITH THIS MACHINE IS NOT RECOMMENDED. For best power and safety, plug the machine directly into a dedicated, grounded electrical outlet that is within the supplied cord length of the machine.

If an extension cord needs to be used, it should only be for a limited operation of the machine. The extension cord should be as short as possible in length, and have a minimum gauge size of 14AWG.

⚠ WARNING: Check extension cords before each use. If damaged replace immediately. Never use a tool with a damaged cord, since touching the damaged area could cause electrical shock, and serious injury.

Use a proper extension cord. Only use cords listed by Underwriters Laboratories (UL). Other extension cords can cause a drop in line voltage, resulting in a loss of power and overheating of tool. When operating a power tool outdoors, use an outdoor extension cord marked "W-A" or "W". These cords are rated for outdoor use and reduce the risk of electric shock.

⚠ WARNING: Keep the extension cord clear of the working area. Position the cord so that it will not get caught on lumber, tools or other obstructions while you are working with your power tool.

* Canadian electrical codes require extension cords to be certified SJT type or better.

** The use of an adapter in Canada is not acceptable.

NOTE: See page 20 for complete wiring diagram.

SAFETY INSTRUCTIONS

SPECIFIC SAFETY INSTRUCTIONS FOR JOINTERS

This machine is intended for the surfacing of natural, solid woods. The permissible workpiece dimensions must be observed (see Technical Specification). Any other use not as specified, including modification of the machine or use of parts not tested and approved by the equipment manufacturer can cause unforeseen damage and invalidate the warranty.

ATTENTION: Use of this jointer still presents risks that cannot be eliminated by the manufacturer. Therefore, the user must be aware that wood working machines are dangerous if not used with care and all safety precautions are adhered to.

1. Do not operate this machine until you have read all of the following instructions.
2. Do not attempt to operate this machine until it is completely assembled and properly grounded.
3. Do not turn ON this machine if any pieces are damaged or missing.
4. If you are not familiar with the operation of the machine, obtain assistance from a qualified person.
5. Always wear approved, safety protective eye wear and hearing protection when operating this machine.
6. Always wear a dust mask and use adequate dust collection and proper ventilation.
7. Do not wear loose clothing or jewelry when operating this machine. Keep long hair tied back.
8. Always make sure the power switch is in the OFF position prior to plugging in the machine.
9. Always make sure the power switch is in the OFF position and the machine is unplugged when doing any cleaning, assembly, setup operation, or when not in use.
10. Make sure all safety guards and hardware are securely tightened before operating the machine.
11. Never start the jointer with the work piece on or near the cutterhead.
12. Check the depth of cut setting before turning the jointer on.
13. Never start the cut until the cutterhead reaches full speed.
14. Regularly check that the blades are locked tight in the cutterhead.
15. Always keep hands and fingers away from the cutterhead, chip exhaust opening, belts and pulleys to prevent injury.
16. Always use push blocks when jointing. Never place hands directly over the cutterhead.
17. Never joint wood less than 10" long, widths under 3/4", or material less than 1/2" thick.
18. Never make cuts deeper than 1/8". Multiple cuts, 1/16" or less, produce better finish results.
19. Make sure there are no loose knots, nails, staples, dirt or foreign objects in the work piece to be surfaced.
20. Use extra caution with large, warped, very small or awkward work pieces.
21. Use extra supports (roller stands, saw horses, tables etc, for any work pieces large enough to tip when not held down to the jointer's infeed and outfeed table surfaces.
22. Surface wood in the same direction of the grain, not across the grain. Never plane end cuts or end grain.
23. Joint only one work piece at a time. Vary the feeding of the work pieces along the cutterhead, center/left/right, so that all of the knives get used and thus remain sharp, longer.
24. Never back the workpiece towards the in-feed table.
25. Never reach inside of a running machine, and avoid awkward operations and hand positions where a sudden slip could cause fingers or a hand to move into the cutterhead.
26. Do not clear a jammed work piece while the machine is running. Stop the machine, unplug it from the power source, and then remove the jammed work piece.
27. Keep your face and body to one side of the machine during use, out of line with a possible 'kick back' (lumber caught in by the rotating cutterhead and thrown back towards the operator).
28. The use of any accessories or attachments not recommended may cause injury to you and damage your machine.
29. Sharpen or replace dull or chipped knives immediately, as injury to the user, or the machine, may result.
30. Replacement knives/inserts should be from, or through a source recommended by the manufacturer.
31. Remove material or debris from the work area. Keep work area neat and clean.

CALIFORNIA PROPOSITION 65 WARNING: Some dust created by power sanding, sawing, grinding, drilling, and other construction activities contains chemicals known to the State of California to cause cancer and birth defects or other reproductive harm. Your risk from exposure to these chemicals varies, depending on how often you do this type of work. To reduce your exposure, work in a well-ventilated area and with approved safety equipment, such as dust masks that are specially designed to filter out microscopic particles.

For more detailed information about California Proposition 65 log onto rikontools.com.

GETTING TO KNOW YOUR MACHINE

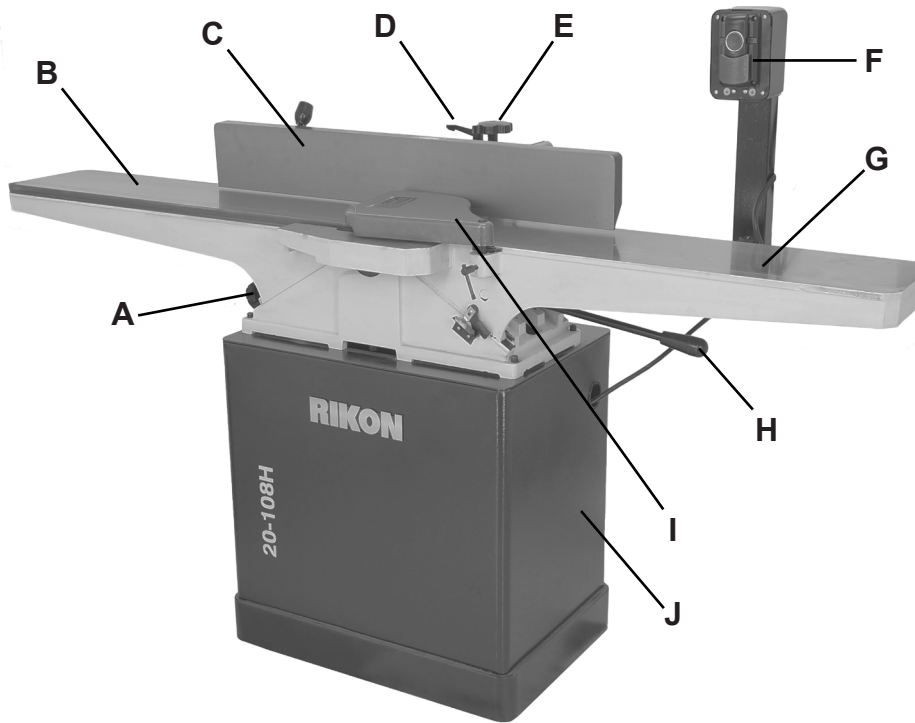

- A Outfeed Table Adjustment Knob
- B Outfeed Table
- C Fence
- D Fence Lock
- E Fence Adjustment Knob
- F On / Off Switch
- G Infeed Table
- H Infeed Table Adjustment Lever
- I Cutterhead Guard
- J Cabinet Stand

**SEE PAGES 22 thru 26
FOR THE
PARTS DIAGRAMS AND
PARTS LISTS**

CONTENTS OF PACKAGE

Model 20-108H Jointer is shipped in two boxes.

Unpacking and Clean-up

1. Carefully remove all contents from the shipping carton. Compare the contents with the list of contents to make sure that all of the items are accounted for, before discarding any packing material. Place parts on a protected surface for easy identification and assembly. If any parts are missing or broken, please call RIKON Customer Service (877-884-5167) as soon as possible for replacements. **DO NOT** turn your machine ON if any of these items are missing. You may cause injury to yourself or damage to the machine.
2. Report any shipping damage to your local distributor.
3. Clean all rust protected surfaces with ordinary house hold type grease or spot remover. Do not use; gasoline, paint thinner, mineral spirits, etc. These may damage painted surfaces.
4. Apply a coat of paste wax to the tables to prevent rust. Wipe all parts thoroughly with a clean dry cloth. Be careful when working, as the jointer insert knives are sharp and may cause injury if touched.
5. Set packing material and shipping carton aside. Do not discard until the machine has been set up and is running properly.

CONTENTS OF PACKAGE

LOOSE PARTS IN CARTON 1

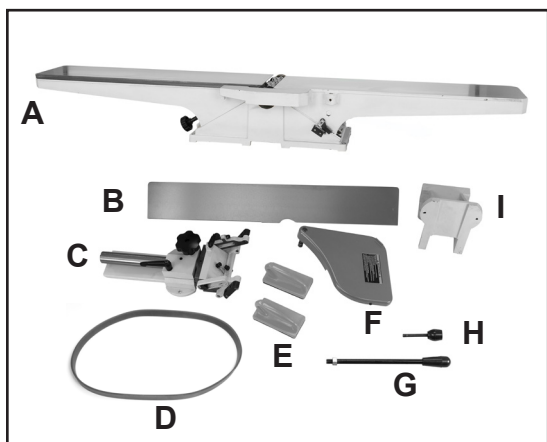

LOOSE PARTS IN CARTON 2

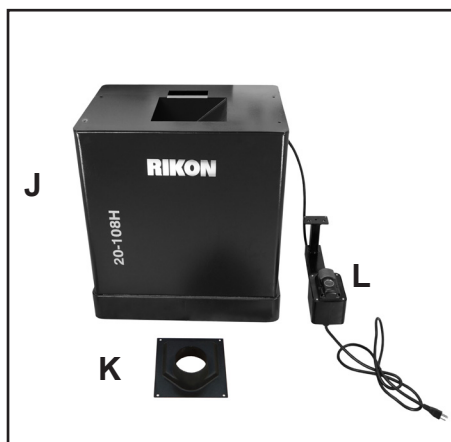

HARDWARE

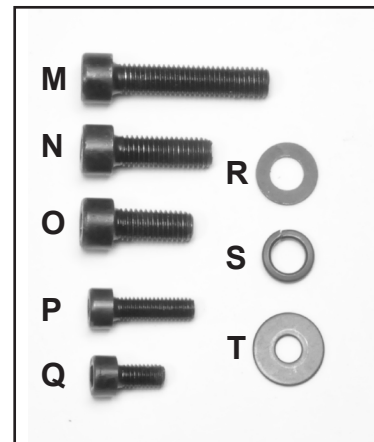

LIST OF LOOSE PARTS

- | | | |
|---------------------------------|-----------------------------------|----------------------------|
| A. Jointer Top | H. Fence Tilt Handle | O. M8 x 20 Allen Bolt (x4) |
| B. Fence | I. Fence Mounting Bracket | P. M6 x 25 Allen Bolt (x4) |
| C. Fence Slide Bracket Assembly | J. Jointer Stand & Motor Assembly | Q. M6 x 12 Allen Bolt (x1) |
| D. Drive Belt | K. Dust Port & Hardware | R. M8 Flat Washer (x4) |
| E. Push Blocks (2) | L. Switch & Switch Post Assembly | S. M8 Lock Washer (x4) |
| F. Cutterhead Guard | M. M8 x 45 Allen Bolt (x4) | T. M6 Flat Washer (x1) |
| G. Height Adjustment Lever | N. M8 x 40 Allen Bolt (x4) | U. Wrenches (not shown) |

INSTALLATION

MOVING & INSTALLING THE JOINTER

CAUTION When moving the jointer, lift the unit from under the cabinet base. Refrain from using the infeed and outfeed tables, as they are factory set and should not be disturbed. **DO NOT** carry or move the machine using the fence assembly, safety guard, dust chute or hand wheels.

1. The machine should be firmly bolted to the floor or mobile base (not included) to avoid any movement of the machine during use. The jointer's base has holes in each of the four corners for this purpose (hardware is not included).
2. Position the machine on a solid, level surface that is located in an area that ample space in front and in back of the jointer for the moving of lumber to be milled. Align the machine so that during use, any kickback will not face aisles, doorways, or other work areas that bystanders may be in. Do not locate or use the machine in damp or wet conditions.



WARNING

THE MACHINE MUST NOT BE PLUGGED IN AND THE POWER SWITCH MUST BE IN THE 'OFF' POSITION UNTIL ASSEMBLY IS COMPLETE.

INSTALLATION TIP: The use of mobile bases to increase portability are common for stationary jointers. Consider starting your assembly with the mobile base of your choice; building the jointer within the base. This will make it easier to install now rather than lifting a fully assembled jointer later.

TOOLS REQUIRED FOR ASSEMBLY

Phillips Head Screwdriver, 4mm Allen Wrench, 13mm or an Adjustable Wrench

ASSEMBLY



WARNING

THE MACHINE MUST NOT BE PLUGGED IN AND THE POWER SWITCH MUST BE IN THE 'OFF' POSITION UNTIL ASSEMBLY IS COMPLETE.

JOINTER TOP ASSEMBLY

1. Remove rear door of the jointer stand.
2. Place jointer top assembly on top of stand, making sure the pulleys face the rear of the cabinet. Ask a friend for assistance with this step.

(DO NOT LIFT BY TABLE ENDS, LIFT FROM CENTER OF CASTING)

3. Line up the four holes in stand top with holes in the bed assembly. Fig. 1.

4. Install the jointer top to the stand by using four M8 x 40mm Allen bolts, four lock washers and four flat washers. Fig. 2.

DRIVE BELT INSTALLATION

1. Loosen the four 13mm motor mounting bolts and nuts on the outer slide rail.
2. Thread the drive belts through the opening in the stand and hang it on the spindle pulley.
3. Lift up the motor and center the drive belts on the motor pulley. Fig. 3.
4. Allow the weight of the motor to determine the proper belt tension. The drive belts should be set between 3/8" and 1/2" deflection when side pressure is applied. Fig. 4.
5. Tighten the four 13mm motor mounting bolts and nuts on the outer slide rail.

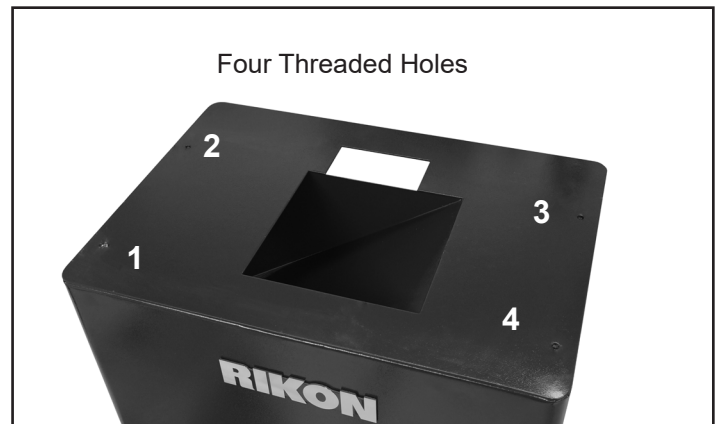

FIG. 1



FIG. 2

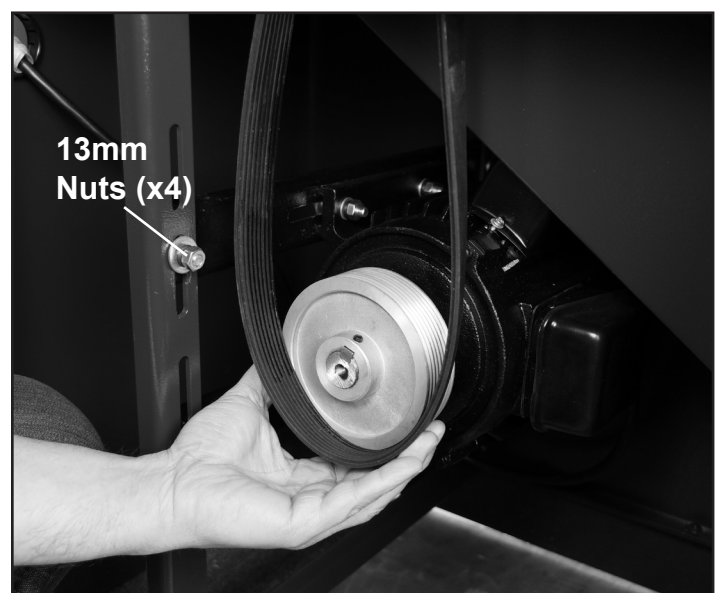
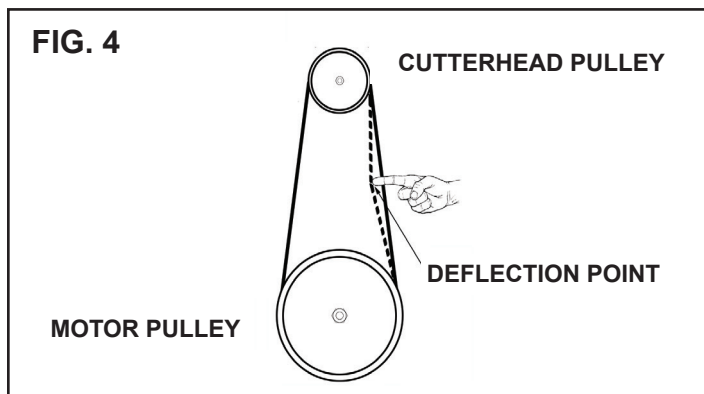

FIG. 3

ASSEMBLY



THE MACHINE MUST NOT BE PLUGGED IN AND THE POWER SWITCH MUST BE IN THE 'OFF' POSITION UNTIL ASSEMBLY IS COMPLETE.

DRIVE BELT & PULLEY ALIGNMENT

The procedure below will ensure drive belt longevity and reduce vibration. If the pulleys are not set correctly, excess wear to the belts and power transfer may be reduced.

1. Loosen the four 13mm motor mounting nuts holding the motor onto the inner slide rail. Fig. 5.
2. Using a straight edge (Fig. 6.) align the face of the cutterhead pulley to the motor pulley by sliding the motor in the appropriate direction.
3. After the pulleys are properly aligned, tighten the four 13mm motor mounting nuts holding the motor onto the inner slide rail. Fig. 5.
4. Install the rear door of the jointer stand which was removed in section "Jointer Top Assembly", page 9.

INSTALLING THE FENCE

Locate the Fence Mounting Bracket and four M8 x 45mm Allen bolts.

The Fence Mounting Bracket attaches over the cutterhead pulley at the rear of the jointer top.

1. Hold the Fence Mounting Bracket (A) over the cutterhead pulley and align the mounting holes (B) to the jointer base. FIG. 7.

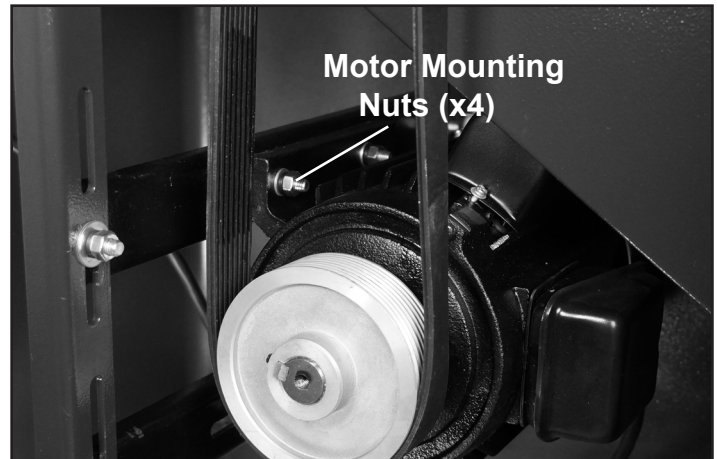

FIG. 5

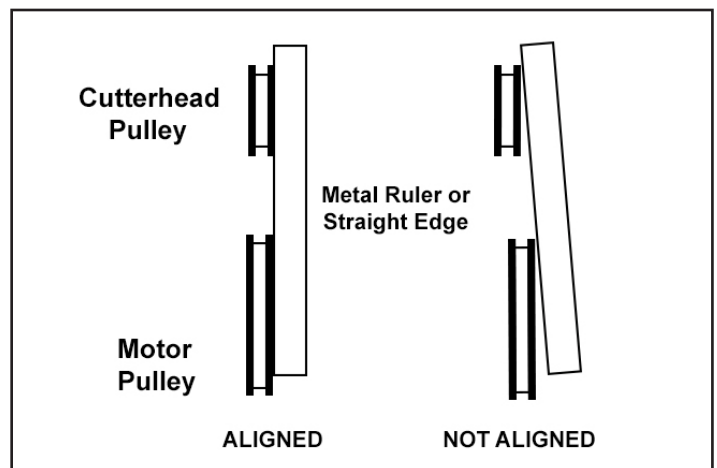

FIG. 6

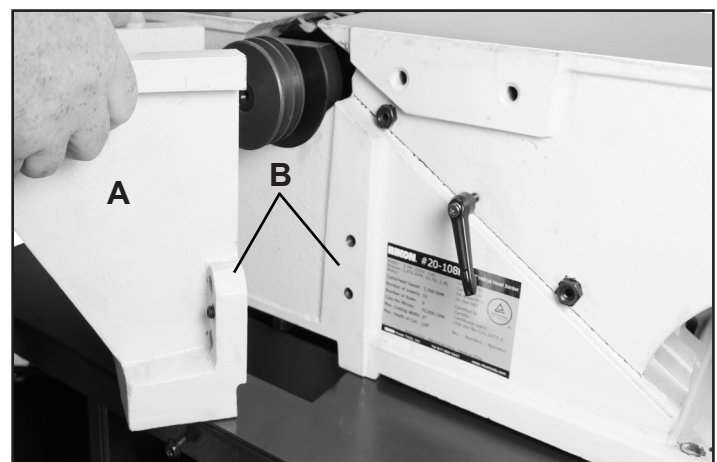

FIG. 7

CONTINUED ON PAGE 11

ASSEMBLY

INSTALLING THE FENCE

CONTINUED FROM PAGE 10

2. Attach the Fence Mounting Bracket to the rear of the jointer body by using the four M8 x 45mm Allen bolts. FIG. 8.

3. Next locate the Fence Slide Bracket Assembly and rest it on top of the Fence Mounting Bracket.

Secure using two M8 x 20mm Allen bolts and two 8mm flat washers. FIG. 9.

4. Mount the Fence Angle Bracket (A- Fig. 9) to the Fence Slide Bracket Assembly by using two M8 x 25mm Allen bolts and two 8mm flat washers (B-Fig. 9).

NOTE: The two M8 x 25mm Allen bolts and two 8mm flat washers are pre-installed in the Fence Angle Bracket.

5. Mount the Fence to the Fence Angle Bracket Assembly by using two M6 x 20mm Allen bolts. FIG. 10.

6. Thread the Fence Tilt Handle on the rear of the Fence. FIG. 11.

NOTE: There are two threaded holes on the rear of the Fence. Install the Fence Tilt Handle in the threaded hole that is most comfortable and convenient for you.

⚠ WARNING THE MACHINE MUST NOT BE PLUGGED IN AND THE POWER SWITCH MUST BE IN THE OFF POSITION UNTIL ALL ADJUSTMENTS ARE COMPLETE.



FIG. 8

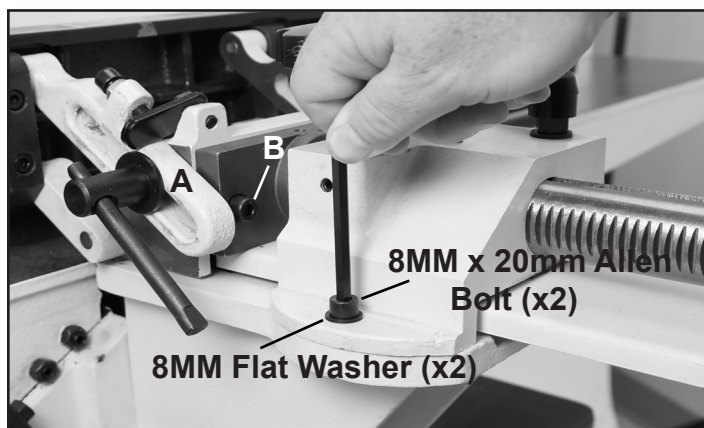

FIG. 9

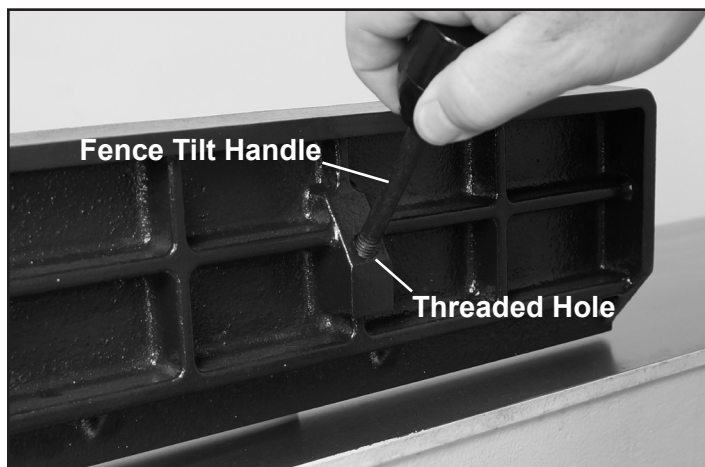

FIG. 11

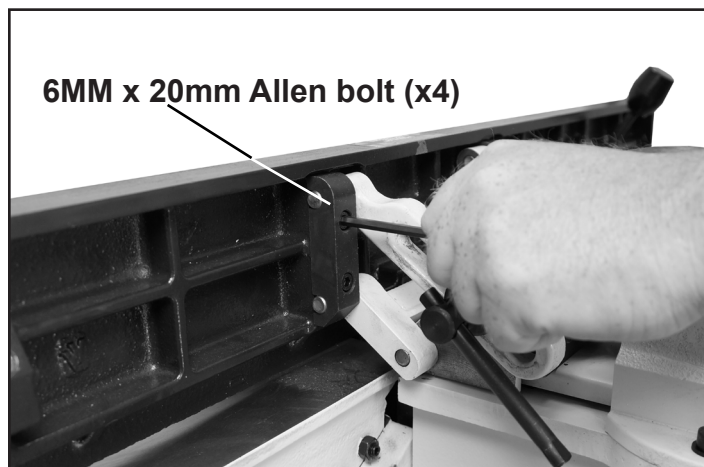

FIG. 10

ASSEMBLY



WARNING

THE MACHINE MUST NOT BE PLUGGED IN AND THE POWER SWITCH MUST BE IN THE OFF POSITION UNTIL ALL ADJUSTMENTS ARE COMPLETE.

DUST PORT ASSEMBLY

A Dust Port (A) is supplied with the jointer to help connect it to a standard 4 inch vacuum hose.

1. Tighten the two upper Screws (B) with a Phillips screwdriver, and tighten the two lower Screws (C) with a Phillips screwdriver when the dust port is in proper location. FIG. 12.

NOTE: It is extremely important that a dust collection system is used with this jointer to eliminate harmful airborne dust, prevent the build-up of chips that may jam the cutterhead, and to keep the working area clean of debris. Make sure all connections are secure and your dust collector is turned on before any milling of lumber is done.

However, if you do not plan to use a dust collector, then there is no need to attach this dust port to the jointer. Chips ejected from the operating machine should be collected and disposed of immediately to keep the area clean and to avoid accidents.

INSTALLING THE CUTTERHEAD GUARD

1. Turn spring pin (A) approximately one-half revolution clockwise and hold.
2. Insert guard post into hole in table. Make sure spring pin rests and places pressure against the table casting. FIG. 13.

INSTALLING THE INFEEED TABLE LEVER

1. Locate the Infeed Table Lever and install into the threaded hole of the Lifting Assembly under the Infeed Table.
2. Once the Infeed Table Lever is fully threaded into the Lifting Assembly tighten the 19MM locking nut to secure into position. FIG. 14.

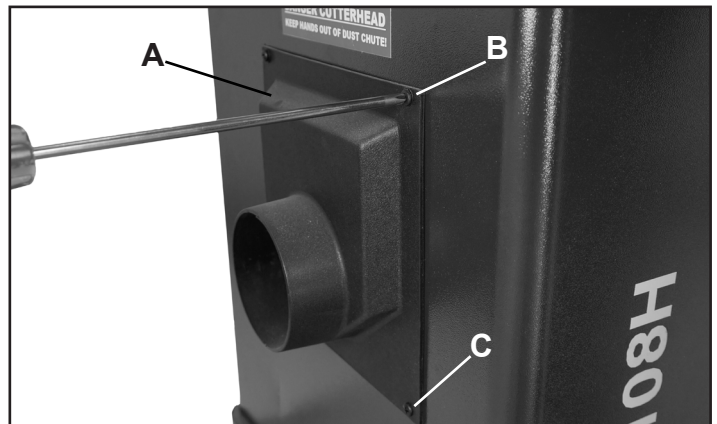

FIG. 12

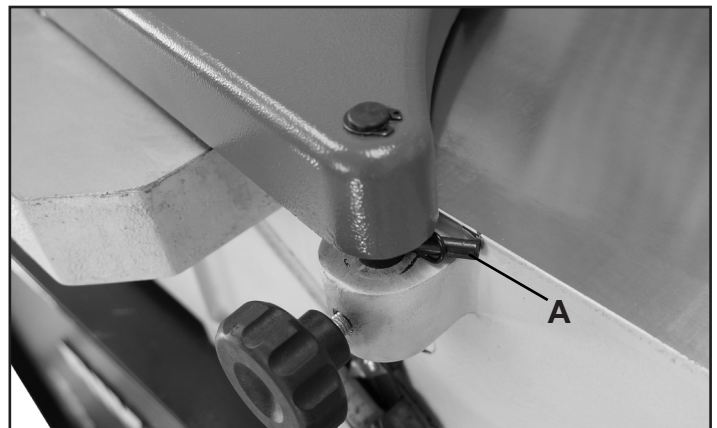

FIG. 13

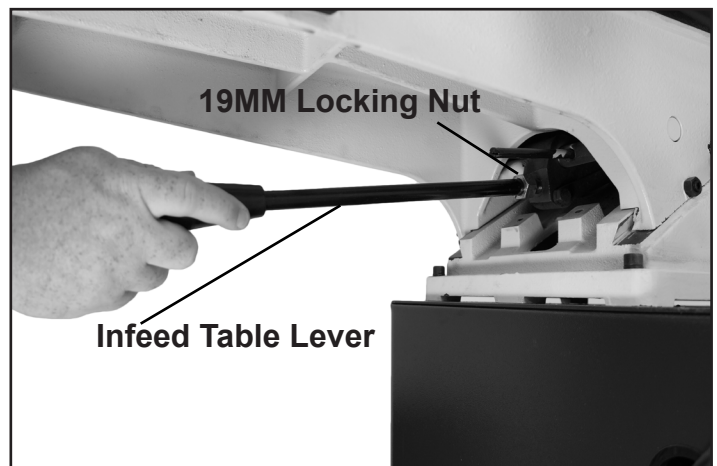

FIG. 14

ASSEMBLY

⚠ WARNING THE MACHINE MUST NOT BE PLUGGED IN AND THE POWER SWITCH MUST BE IN THE OFF POSITION UNTIL ALL ADJUSTMENTS ARE COMPLETE.

OUTFEED TABLE ADJUSTMENT KNOB

1. Locate the Outfeed Table Adjustment Knob, Allen Cap Screw M6 x 12mm and 6mm Flat Washer.
2. Insert the Outfeed Table Adjustment Knob onto the square receiver of the Table Adjustment Screw Shaft located under the Outfeed Table. Secure using the Allen Cap Screw M6 x 12mm and 6mm Flat Washer. FIG. 14A.

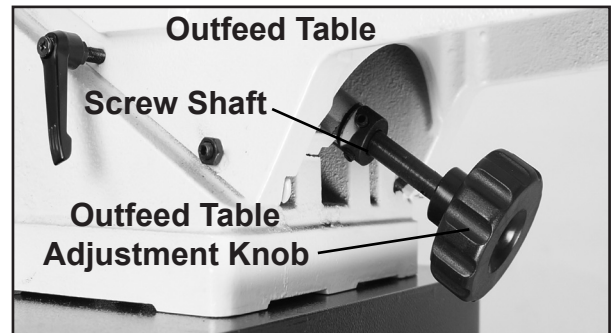

FIG. 14A

SWITCH POST INSTALLATION

NOTE: The switch is prewired to the motor. No additional wiring is needed at this point.

1. Locate the Switch Post and position it to the rear on the infeed table.

NOTE: The two M8 x 20mm Allen bolts and two 8mm flat washers are pre-installed in the rear of Infeed Table casting.

2. Install the Switch Post to the rear of the infeed table and secure using two M8 x 20mm Allen bolts and two 8mm flat washers. A-FIG. 15.

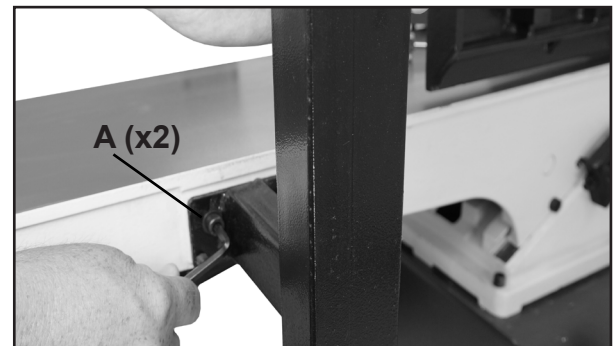

FIG. 15

OPERATION

NOTICE: This operations section was designed to give instructions on the basic operations of this jointer. However, it is in no way comprehensive of every jointer operation. It is strongly recommended that you read books, trade magazines, or get formal training to maximize the potential of your jointer while minimizing the risks.

NOTICE: This jointer is designed to surface natural wood ONLY.

⚠ WARNING Before turning on the machine, review the safety precautions listed on pages 3 to 6. Make sure that you fully understand the features, adjustments and capabilities of the machine that are outlined throughout this manual.

STARTING AND STOPPING JOINTER

1. The 20-108H 8" Jointer is equipped with a safety switch with a "lockout" feature to prevent unintended use. A hole (A-FIG 16) is located behind the "ON" button to receive a locking device (not included).

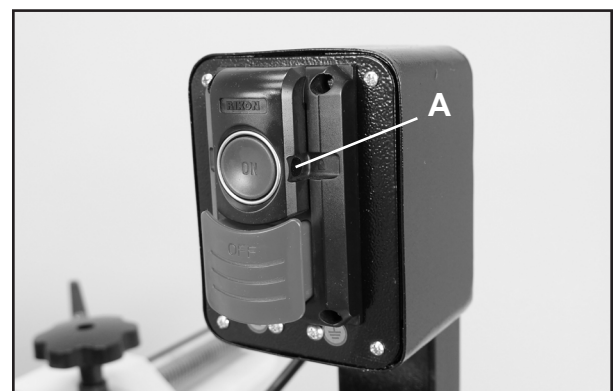

FIG. 16

CONTINUED ON PAGE 14

OPERATION

CONTINUED FROM PAGE 13

STARTING AND STOPPING JOINTER

2. The ON/OFF switch is located on the front of the jointer. To turn the jointer "ON", depress (A) the blue round button until a "snap" sound is heard.

3. To turn the jointer "OFF", depress (B) the red paddle until a "snap" sound is heard. FIG 17.

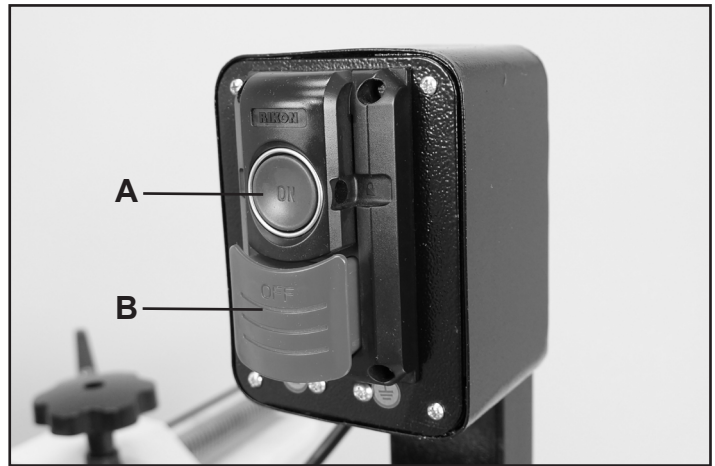

FIG. 17

DIRECTION OF GRAIN

Feed the wood into the jointer with the grain to obtain a smooth surface. FIG 18.

Avoid feeding work into the jointer against the grain. The result will be chipped and splintered edges on the wood surface.

CAUTION: DO NOT continuously use the jointer at the maximum depth of cut, 1/8 in. (3mm), as it will put excessive stress on the motor which will damage it.

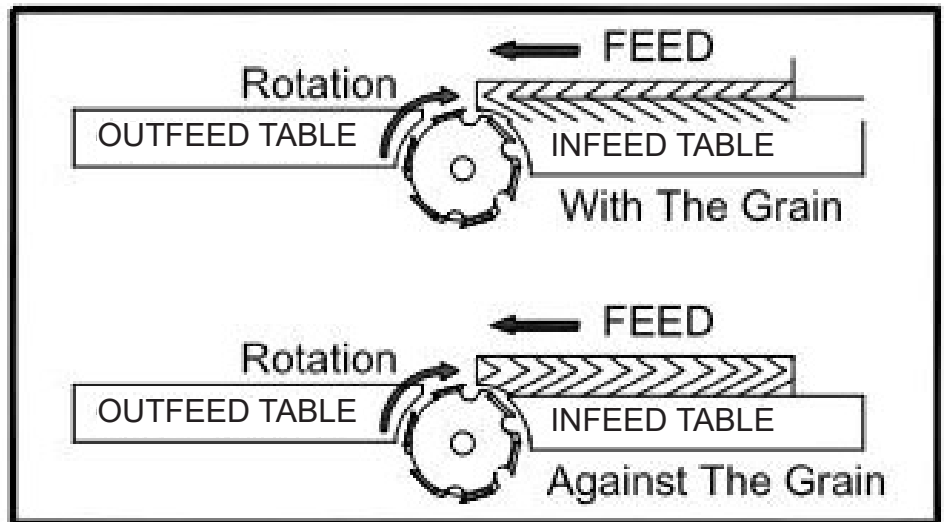

FIG. 18

JOINTER OPERATION

The function of the jointer is to surface plane flat, one side or edge of a board/workpiece.

To use the jointer:

1. Connect your Dust Collector Hose to the Dust Port.

It is extremely important that a dust collection system is used with this jointer to eliminate harmful airborne dust, prevent the build-up of chips that may jam the cutterhead, and to keep the working area clean of debris.

NOTE: Workpiece dimensions for jointing:

- Length: use a push block or stick to feed boards shorter than 12"; use support rollers for long boards for safe control and accurate planing.
- Width: maximum 6".
- Thickness: minimum 1/2". The use of push blocks is necessary when face planing thin material.
- Depth of Cut: maximum 1/8". Multiple cuts of 1/16" or less, produce better finish results.

OPERATION

FEEDING THE WORKPIECE

Place the workpiece on top of the right, infeed table. The workpiece will be cut on its underside by the rotating cutterhead knives. When jointing, the feeding direction of the workpiece is right-to-left over the cutterhead. FIG. 19.

1. Assume the proper operating position: stand to the side of the infeed table with feet apart for stability through the whole cutting process. FIG. 19.
2. Set the jointer fence position and angle as required.
3. Set the depth of cut / thickness (See below).
4. Place the workpiece against the jointer fence for support through the cutting action. FIG. 20.
5. Make sure that the cutterhead guard is against the workpiece for user protection.

NOTE: For jointing the edge of a board, set the workpiece against the fence. The spring action blade guard should be touching the workpiece, covering the cutterhead knives. Push the workpiece slowly and steady over the cutterhead. Ensure that the fence is set at true 90° (or any other angle required (see page 10) and the workpiece is kept flush against the fence.

For planing the face of a board or workpiece, follow the same procedure as above.

6. Turn the machine on and place the workpiece on the infeed table. Feed the workpiece toward the cutterhead, FIG. 21, exerting downward pressure until the workpiece clears the cutterhead on the outfeed table side. Always keep your hands away from the cutterhead to avoid any accidents.

NOTE: The use of push blocks is recommended.

Run boards at different positions along the width of the cutterhead to utilize the full length of the cutting knives. Jointing in one area of the cutterhead will quickly dull the insert cutters in that area.

SETTING DEPTH OF CUT

The jointer can be set to cut any depth from a very thin shaving to 1/8" deep. The pointer (A) on the scale (B) is to indicate the depth of cut. FIG. 22.

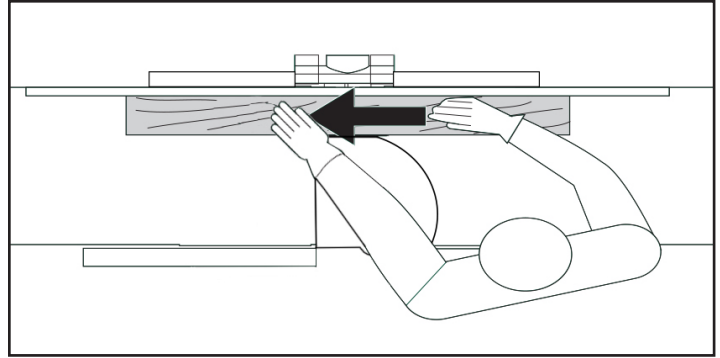

FIG. 19

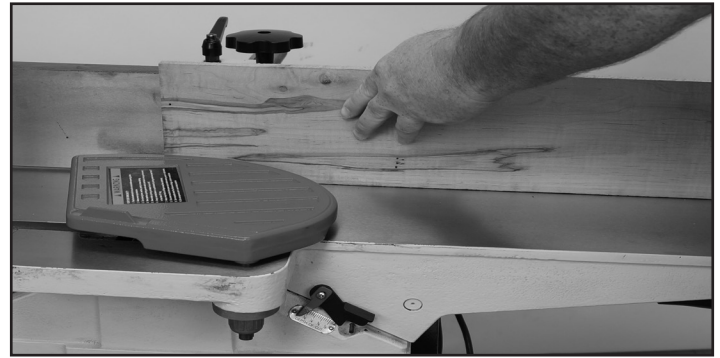

FIG. 20

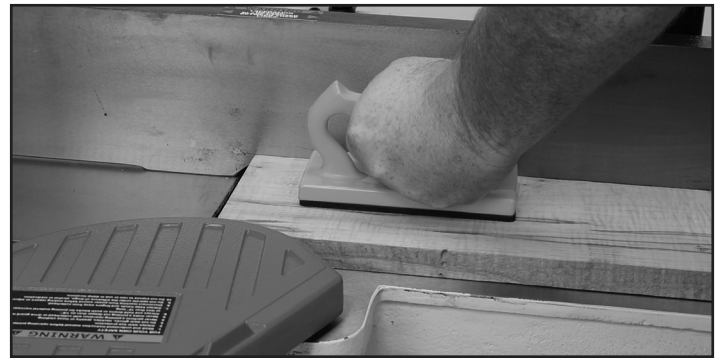

FIG. 21

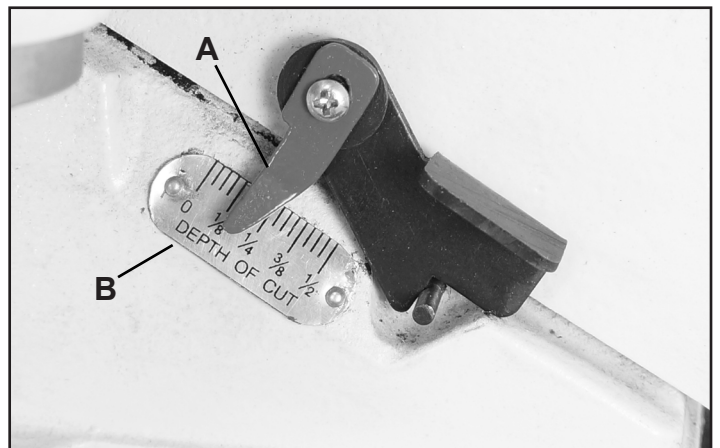

FIG. 22

ADJUSTMENTS

⚠ WARNING THE MACHINE MUST NOT BE PLUGGED IN AND THE POWER SWITCH MUST BE IN THE OFF POSITION UNTIL ALL ADJUSTMENTS ARE COMPLETE.

FENCE ADJUSTMENTS

1. To move the fence across the table, loosen the lock lever (A), then turn the knob (B) until the fence is in the desired position on the table and then retighten the lock lever. FIG. 23.

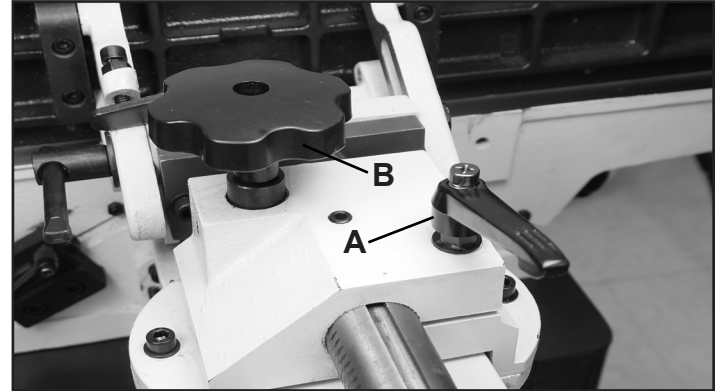

FIG. 23

NOTE: The handle direction of the lock lever (A) can be repositioned by pulling up the lever and repositioning it on the nut located underneath the lever.

2. To tilt the fence, loosen the lock lever (A), and tilt the fence to the desired angle. Then retighten the lock lever. FIG. 24.

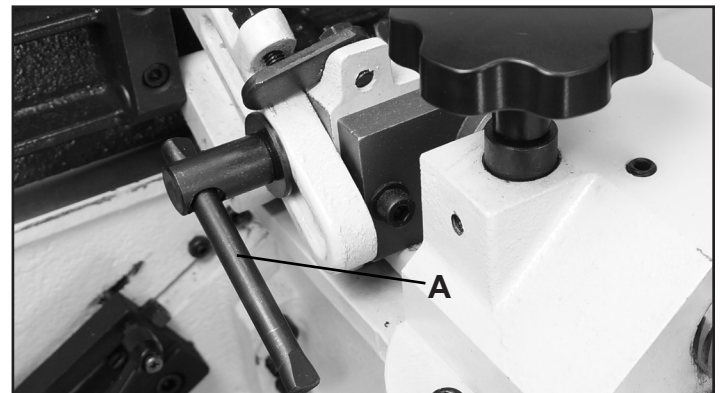

FIG. 24

3. The fence has adjustable positive stops at the most used fence positions of 90 degrees and 135 degrees.

SETTING THE FENCE TO 90° and 135°

To check and adjust the positive stops to the 90 and 135 degree settings:

4. Put a square on the table with one end against the fence and adjust the fence until it is exactly 90 degrees to the table. FIG. 25.

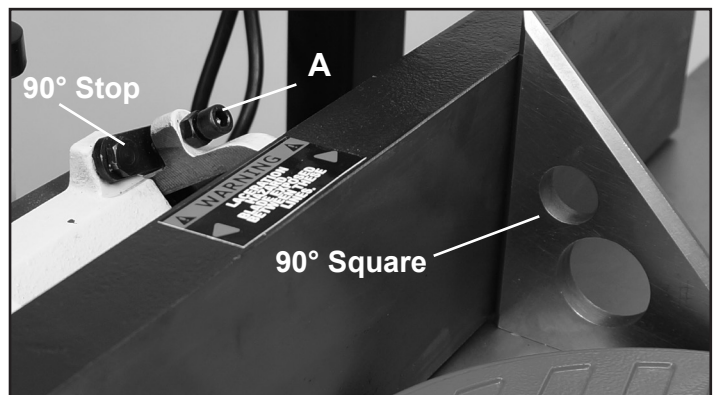

FIG. 25

5. Loosen the locking nut with a 13mm hex wrench and adjust the Allen screw (A) until a 90 degree setting is reached. Tighten the locking nut to retain the adjustment. FIG. 25.

6. To check the 135 degree setting flip the 90 degree stop tab away from the 90 degree stop bolt. Put a square on the table with one end against the fence and adjust the fence until it is exactly 135 degrees to the table. FIG. 26.

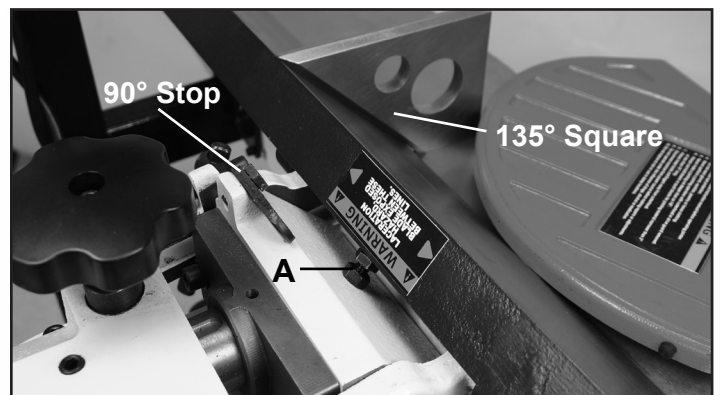

FIG. 26

NOTE: With the fence set at 135°, the jointer will produce a 45° bevel on your workpiece.

7. Loosen the locking nut with a 13mm hex wrench and adjust the stop bolt (A) until a 135 degree setting is reached. Tighten the locking nut to retain the adjustment. FIG. 26.

ADJUSTMENTS

⚠ WARNING THE MACHINE MUST NOT BE PLUGGED IN AND THE POWER SWITCH MUST BE IN THE OFF POSITION UNTIL ADJUSTMENTS ARE COMPLETE.

ROTATING OR REPLACING KNIFE INSERTS

This machine has a helical cutterhead with four rows of carbide knife inserts. Each of the 40 inserts on the cutterhead are indexed and have four sharpened sides. If the knives become dull, or one becomes nicked, simply loosen the retaining screws with the supplied star head screwdriver, lift up and rotate the inserts to a new sharpened edge. No setting is required, as the cutterhead has been machined to automatically index and set the inserts in proper position for use. When all four sides of an insert are dull, the insert can be easily removed and a new carbide insert placed in the location.

To rotate or remove a carbide insert knife:

1. Unplug power cable.
2. Remove the screw (#203), that holds the Insert in the cutterhead, and the insert cutter (#202). FIG. 28.
3. While the insert is removed, clean any resin buildup or trapped dust from the surfaces of the cutterhead with a suitable solvent. A tooth brush works well for safe cleaning around the sharp inserts. Any accumulated dust can affect the seating of the insert in the cutterhead.
4. Rotate the insert so that a new sharpened edge is in position. The inserts have a indication mark on their top surface corner, so that you can reference the positioning of the dulled or sharpened edges of the insert. FIG. 27 - 29A.
5. Tighten the insert's set screw to lock the insert back in position. DO NOT overtighten the screw or damage to the insert may result. Torque to 50-55 in/lbs.
6. Plug in the power cable when you are ready to resume jointing.

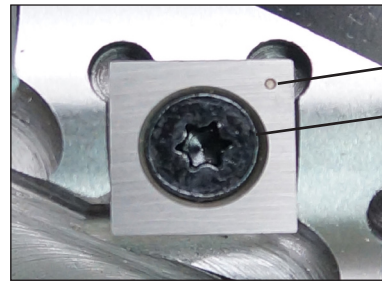

INDEX MARK

STAR HEAD SET SCREW

CARBIDE INSERT KNIFE HAS 4 SHARP EDGES

FIG. 27

⚠ CAUTION Wear gloves when changing knife inserts to avoid the risk of personal injury by cuts that may result from touching the sharp edges!



Remove Screw

FIG. 28

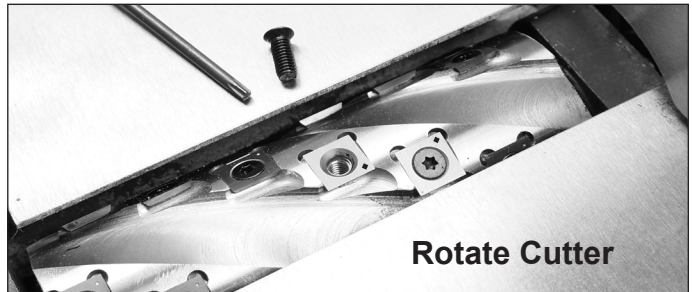

Rotate Cutter

FIG. 28A

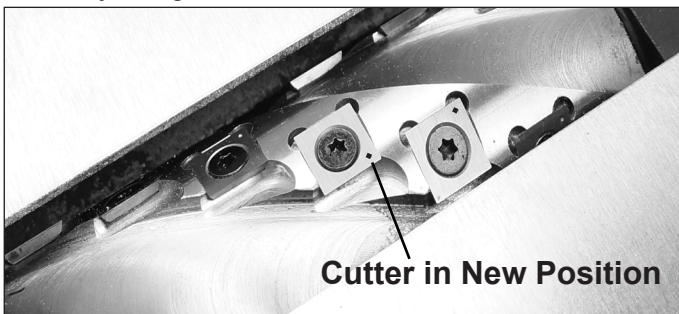

Cutter in New Position

FIG. 29A

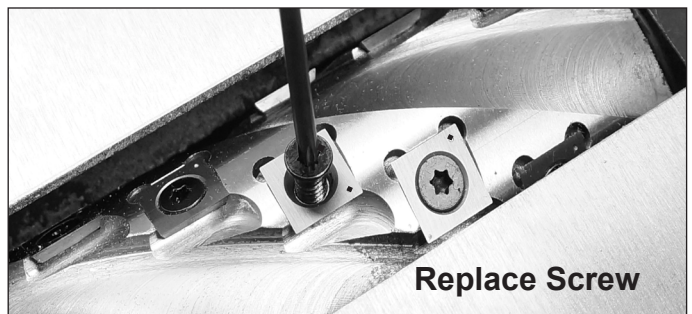

Replace Screw

FIG. 29

ADJUSTMENTS

TABLE ADJUSTMENTS

The infeed and outfeed tables are preset at the factory to be aligned with the cutterhead. To ensure that both tables are aligned, check both table settings and adjust as necessary.

CAUTION This procedure involves close contact with the jointer knife inserts. Wear gloves to prevent injury to the hands. Make sure that the machine is disconnected from the power supply.

1. Remove rear door of the jointer stand.
2. Set the infeed table to the '0' setting on its depth of cut scale. FIG. 30.
4. Rotate the cutterhead so that the knife inserts are at their highest point by pulling on the drive belt until the desired position is set.

3. With a long metal straight edge, place it lengthwise along the outfeed table so that it extends onto the insert cutter at its highest rotation point. Check the measurement on the insert cutter to the far right and then far left on the cutterhead. FIG. 31.

4. If the straight edge does not touch the insert cutter(s), the outfeed table will need to be adjusted.

A. Release the locking lever (A) at the rear of the outfeed table. FIG. 32.

B. Turn the handwheel (B) to adjust the outfeed table until it is parallel with the edge of the cutter(s). FIG. 32.

NOTE: Turning the handwheel clockwise will lift up the table, turning counterclockwise will lower the table.

C. Once the table is set, tighten the locking lever (A) to secure the table in its new setting. FIG. 32.

WARNING THE MACHINE MUST NOT BE PLUGGED IN AND THE POWER SWITCH MUST BE IN THE OFF POSITION UNTIL ALL ADJUSTMENTS ARE COMPLETE.

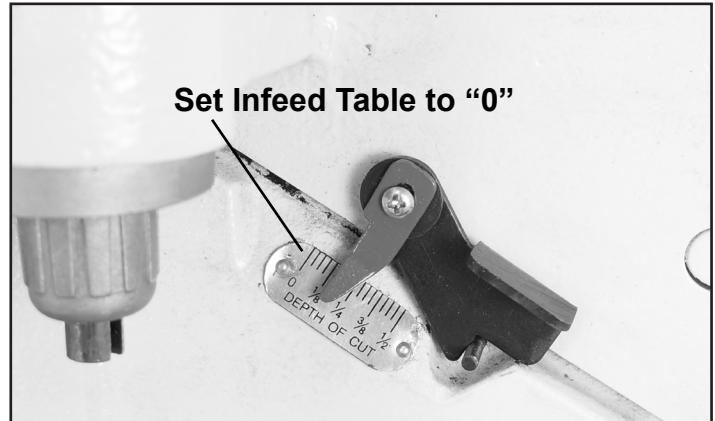

FIG. 30

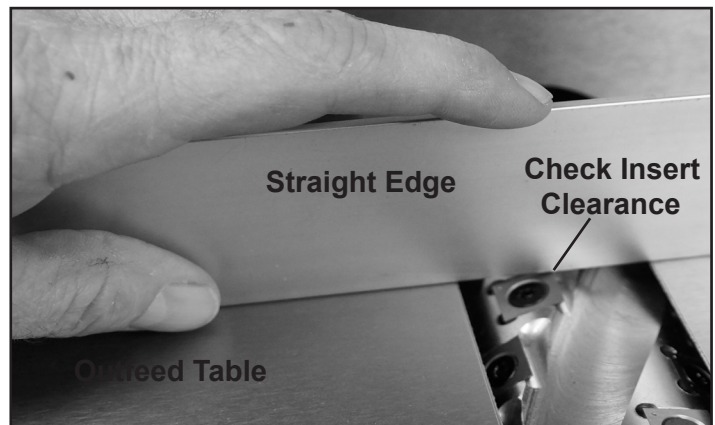

FIG. 31

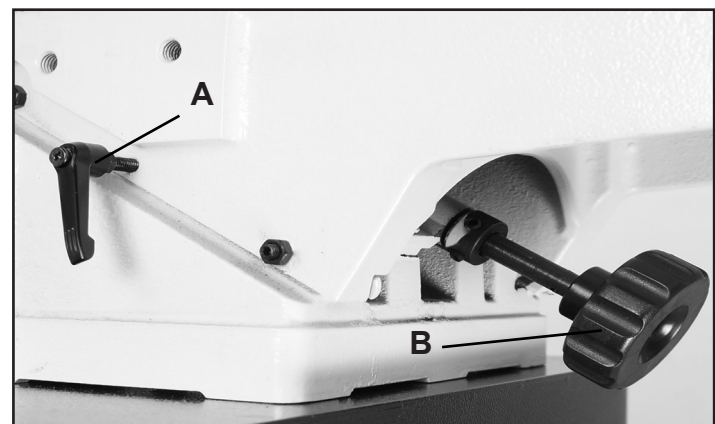

FIG. 32

CONTINUED ON PAGE 19

ADJUSTMENTS

CONTINUED FROM PAGE 18

5. Do the same measurement with the straight edge from the infeed table, to the same insert cutters that were used to measure the outfeed table.

6. Once the infeed and outfeed tables are aligned with the cutterhead, the tables need to be checked to confirm that their surfaces are parallel with each other - ends not tilting or angling down or up from the cutterhead.

5. Lie the straight edge across BOTH tables. FIG. 33. They should be set at the same height and perfectly level to each other.

- If it does, the tables are true to each other.
- If the straight edge does not lie flat across both tables, then the tables must be adjusted. Tune the infeed table to the outfeed table.

6. Loosen the locking lever (A-FIG. 34) at the rear of the infeed table.

Raise or lower the table adjustment handle (not shown) and check the clearance between the straight edge and infeed table as shown in FIG. 33.

Adjust the upper positive stop by unlocking the 10mm lock nut and turning the Allen bolt until the desired result is achieved. Retain the adjustment by tightening the 10mm lock nut.

CHANGING THE DRIVE BELT

1. Remove rear stand panel door.
2. Loosen the the four 13mm mounting bolts and nuts on the outer slide rail.
3. Thread the drive belt through the opening in the stand and hang it on the spindle pulley.
4. Lift up the motor and center the drive belt on the motor pulley. Fig. 35.

5. Allow the weight of the motor to determine the proper belt tension. The drive belt should be set between 3/8" and 1/2" deflection when side pressure is applied. Fig. 36.

5. Tighten the the four 13mm mounting bolts and nuts on the outer slide rail.

6. Install rear stand panel door.

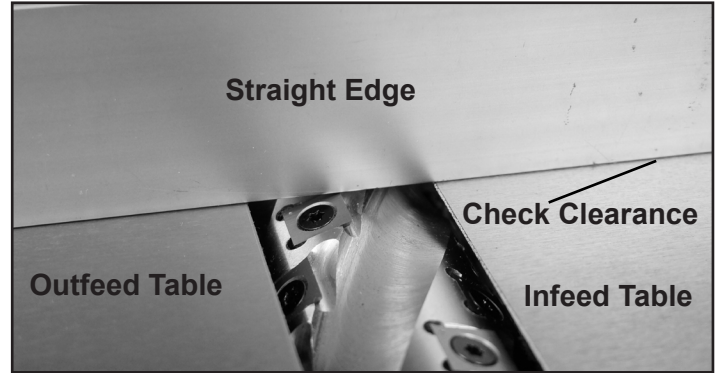

FIG. 33

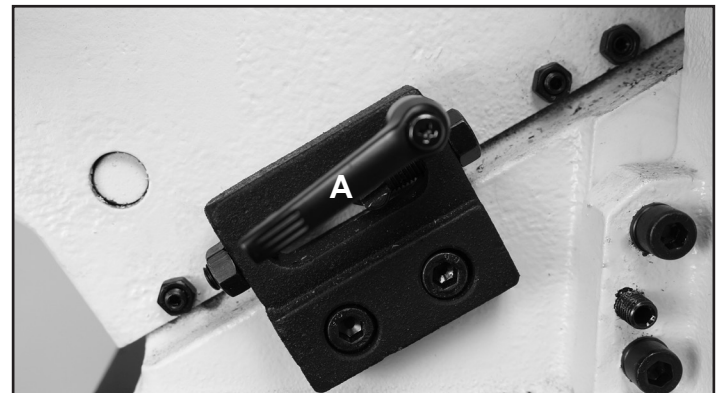

FIG. 34

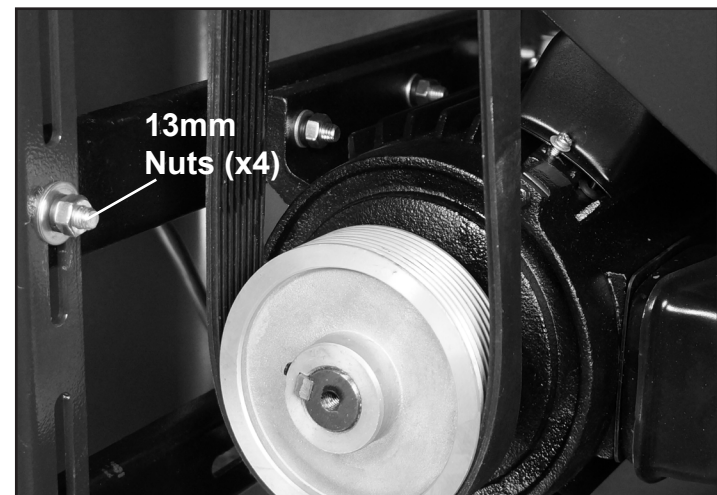
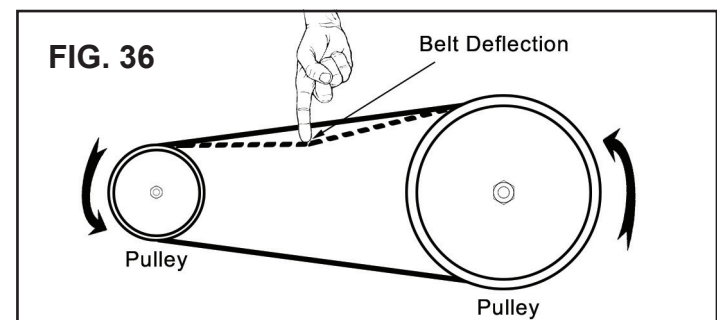

FIG. 35



MAINTENANCE

⚠ WARNING Turn the power switch “OFF” and disconnect the plug from the outlet prior to adjusting or maintaining the machine. DO NOT attempt to repair or maintain the electrical components of the motor. Contact a qualified service technician for this type of maintenance.

1. Before each use:

- Check the power cord and plug for any wear or damage.
- Check for any loose screws or hardware.
- Check the area to make sure it is clear of any misplaced tools, lumber, cleaning supplies, etc. that could hamper the safe operation of the jointer.

2. To avoid a build-up of wood dust, regularly clean all parts of the machine using a soft cloth, brush or compressed air. A general cleaning should be done after every use to avoid future problems and ensure the machine is in ready condition for the next time it is used.

⚠ WARNING If blowing sawdust, wear proper eye protection to prevent debris from blowing into eyes. Air pressure above 50 PSI should not be used as high-pressured air may damage insulation, etc.

3. Check the knife inserts to make sure that they are not loose from the cutterhead, dull or nicked. Making sure that they are in proper operating condition will ensure that the quality of your surfaced lumber will be the best possible.

4. Lubricate all bearing points regularly with a few drops of light motor oil. Cutterhead ball bearings are lifetime lubricated, sealed, and do not need any further care. Keep the drive belt free of oil and grease.

5. Keep the jointer tables free of resin and rust. Clean them regularly with a non-flammable solvent, then coat with a light film of dry lubricant spray, or wax, to enhance passage of work piece on/over the tables. Never use solvents to clean plastic parts, as they could dissolve or damage the material.

⚠ WARNING When cleaning or working on the tables, avoid the risk of personal injury by cuts that may result from touching the knife inserts' sharp edges!

6. Check the drive belt tension after the first 3-5 hrs. of operation to ensure that the belts have not become stretched and loose from their 'breaking in' use. See page 19 for instructions.

Service beyond recommended maintenance on these tools should only be performed by an authorized, qualified technician.

WIRING DIAGRAM

⚠ WARNING This machine must be grounded. Replacement of the power supply cable should only be done by a qualified electrician. See page 5 for additional electrical information.

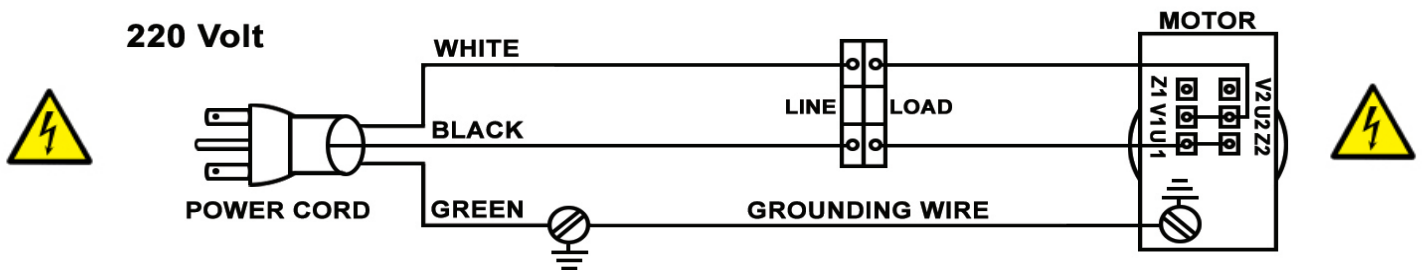

TROUBLESHOOTING



WARNING

FOR YOUR OWN SAFETY, ALWAYS TURN OFF AND UNPLUG THE MACHINE BEFORE CARRYING OUT ANY TROUBLESHOOTING.

SYMPTOM	POSSIBLE CAUSES	SOLUTIONS
Machine will not start.	<ol style="list-style-type: none"> 1. No power 2. Tripped circuit breaker 3. ON / OFF switch not functioning 4. Motor failure 	<ol style="list-style-type: none"> 1. Check power source, plug and wiring. 2. Check and reset circuit breaker. 3. Check position of the switch. Contact local dealer for repair or replacement. 4. Inspect motor for failed components. Contact dealer for repair or replacement.
Circuit Breakers trip and /or Fuses are blown	<ol style="list-style-type: none"> 1. Wrong circuit size for the machine 2. Motor is overloaded under strain from taking too heavy of cut 3. Use of an extension cord 	<ol style="list-style-type: none"> 1. Check circuit/fuse rating and amps of the motor. Install CORRECT rated breaker/fuse. 2. Take lighter cuts in planing lumber. 3. No extension cord, or use heavier gauge cord.
Machine bogs down in the cut	<ol style="list-style-type: none"> 1. Excessive depth of cut 2. Feed rate is too fast 3. Knives are dull 	<ol style="list-style-type: none"> 1. Decrease depth of cut. 2. Reduce feed rate. 3. Replace or sharpen knives.
Cutting rate is not consistent	<ol style="list-style-type: none"> 1. Belts are loose 2. Chips and dust build-up on parts 	<ol style="list-style-type: none"> 1. Check pulleys and belts for tension & wear. 2. Unplug machine and clean all parts.
Jointer fence is not accurate at 90° or 45°	<ol style="list-style-type: none"> 1. Fence stops are not properly adjusted 2. Locking handles are loose 	<ol style="list-style-type: none"> 1. Readjust the fence stops. 2. Check all handles to make sure that they are properly tightened before starting the machine.
'Chatter' marks on lumber	<ol style="list-style-type: none"> 1. Feed rate is too fast 	<ol style="list-style-type: none"> 1. Slow the feed rate down.
Cutterhead slows down when jointing	<ol style="list-style-type: none"> 1. Feed rate is too fast 2. Downward pressure on the cutterhead knives is too great 	<ol style="list-style-type: none"> 1. Slow down feeding the wood over the cutterhead. 2. Apply less downward pressure
Small raised lines are running along the surface	<ol style="list-style-type: none"> 1. Knives are nicked or broken 	<ol style="list-style-type: none"> 1. Rotate insert knives to new sharp edges.
Jointed stock is concave on the back end of the board	<ol style="list-style-type: none"> 1. Knives are set higher than the outfeed table 	<ol style="list-style-type: none"> 1. Raise the outfeed table level with the cutterhead & knives.
Jointed stock is concave on the front end of the board	<ol style="list-style-type: none"> 1. Outfeed table is set higher than the knives 	<ol style="list-style-type: none"> 1. Lower the outfeed table level with the cutterhead & knives.
Stock is concave in the middle of the board	<ol style="list-style-type: none"> 1. Table is out of level 	<ol style="list-style-type: none"> 1. Raise the table ends.
Milled surface is torn - also called 'chip out' or 'tear out'	<ol style="list-style-type: none"> 1. Cutting against the grain 2. Cut is too deep 3. Knives are dull 	<ol style="list-style-type: none"> 1. Cut with the grain. For figured woods, take shallow cuts to minimize tear out. 2. Reduce cutting depth to 1/16" or less. 3. Rotate insert knives to new sharp edges.
Milled surface grain is rough, raised or fuzzy	<ol style="list-style-type: none"> 1. Lumber has a high moisture content 2. Knives are dull 	<ol style="list-style-type: none"> 1. Reduce the moisture content by drying it, or switch to other properly seasoned lumber. 2. Rotate insert knives to new sharp edges.
Milled surface is glossy	<ol style="list-style-type: none"> 1. Cutting depth is too shallow 2. Knives are dull 3. Feed rate is too slow 	<ol style="list-style-type: none"> 1. Increase depth of cut slightly. 2. Rotate insert knives to new sharp edges. 3. Increase feed rate.

PARTS DIAGRAM

20-108H 8" JOINTER TABLE ASSEMBLY

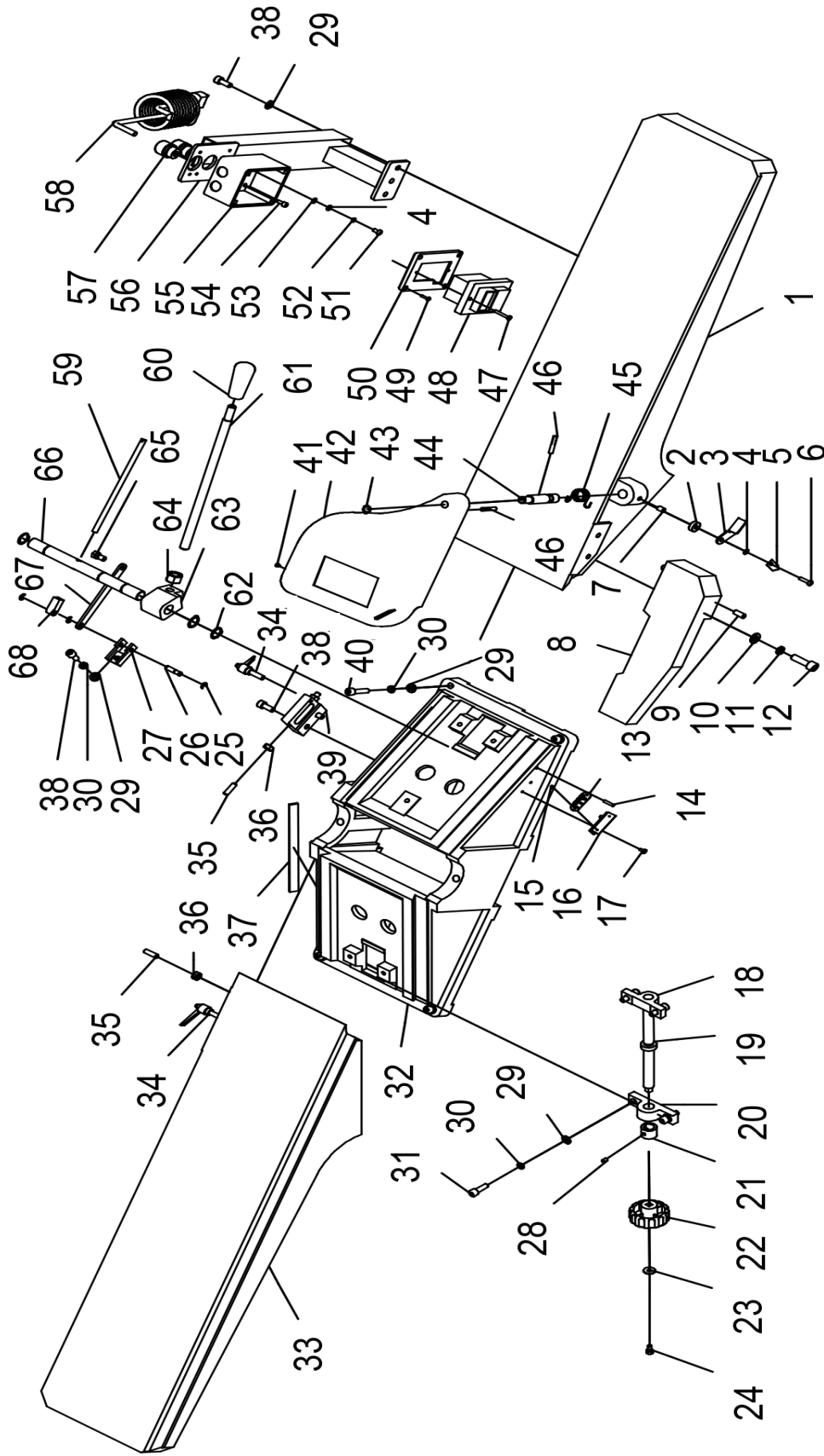

NOTE: Please reference the Manufacturer's Part Number when calling for Replacement Parts. For Parts under Warranty, the Serial Number of your machine is required.

PARTS LIST

20-108H 8" JOINTER TABLE ASSEMBLY

KEY NO.	DESCRIPTION	QTY.	PART NO.	KEY NO.	DESCRIPTION	QTY.	PART NO.
1	INFEED TABLE	1	P20-108H-1	35	SET SCREW M8x25	7	P20-108H-35
2	SPECIAL WASHER	1	P20-108H-2	36	NUT M8	7	P20-108H-36
3	1/8 PLATE	1	P20-108H-3	37	GIB	2	P20-108H-37
4	WASHER 5MM	3	P20-108H-4	38	CAP SCREW M8x20	5	P20-108H-38
5	POINTER	1	P20-108H-5	39	BLOCK	1	P20-108H-39
6	SCREW M5x20	1	P20-108H-6	40	CAP SCREW M8x40	4	P20-108H-40
7	SET SCREW M8x12	1	P20-108H-7	41	RUBBER WASHER	1	P20-108H-41
8	RABBET ARM	1	P20-108H-8	42	CUTTERHEAD GUARD	1	P20-108H-42
9	SET SCREW M8x20	1	P20-108H-9	43	RING M12	1	P20-108H-43
10	FLAT WASHER 10MM	2	P20-108H-10	44	GUARD PIVOT SHAFT	1	P20-108H-44
11	LOCK WASHER 10MM	2	P20-108H-11	45	SPRING	1	P20-108H-45
12	SCREW M10x35	2	P20-108H-12	46	ROLL PIN M6x40	2	P20-108H-46
13	SCALE	1	P20-108H-13	47	TAP SCREW ST4.2x30	2	P20-108H-47
14	PIN M4x20	1	P20-108H-14	48	SWITCH	1	P20-108H-48
15	RIVET M4x20	2	P20-108H-15	49	TAP SCREW ST3.5x16	4	P20-108H-49
16	LABEL PLATE	1	P20-108H-16	50	SWITCH PLATE	1	P20-108H-50
17	DEPTH SCALE	2	P20-108H-17	51	PAN HEAD SCREW M5x10	2	P20-108H-51
18	PAN HEAD SCREW M4x8	1	P20-108H-18	52	LOCK WASHER M5	2	P20-108H-52
19	TABLE ADJUST NUT	1	P20-108H-19	53	SERRATED SPACER M5	2	P20-108H-53
20	BRACKET	1	P20-108H-20	54	CAP SCREW M5x12	4	P20-108H-54
21	RING	1	P20-108H-21	55	SWITCH BOX	1	P20-108H-55
22	HANDWHEEL	1	P20-108H-22	56	SWITCH MOUNT BRACKET	1	P20-108H-56
23	FENDER WASHER M6	1	P20-108H-23	57	STRAIN RELIEF M20x1.5	2	P20-108H-57
24	CAP SCREW M6x12	1	P20-108H-24	58	POWER CORD	1	P20-108H-58
25	E-CLIP M6	3	P20-108H-25	59	SCREW	1	P20-108H-59
26	CAPTIVE PIN	1	P20-108H-26	60	HANDLE KNOB M20	1	P20-108H-60
27	PIVOT ARM BRACKET	1	P20-108H-27	61	LEVER	1	P20-108H-61
28	SET SCREW M6x8	2	P20-108H-28	62	RING M10	3	P20-108H-62
29	FLAT WASHER 8MM	11	P20-108H-29	63	LEVER HUB	1	P20-108H-63
30	LOCK WASHER 8MM	9	P20-108H-30	64	NUT M14	1	P20-108H-64
31	CAP SCREW M8x25	4	P20-108H-31	65	PIVOT LINK STEP BOLT	1	P20-108H-65
32	BASE	1	P20-108H-32	66	INFEED PIVOT SHAFT	1	P20-108H-66
33	OUTFEED TABLE	1	P20-108H-33	67	PIVOT LINK	1	P20-108H-67
34	KNOB M6x30	2	P20-108H-34	68	NUT	1	P20-108H-68

NOTE: Please reference the Manufacturer's Part Number when calling for Replacement Parts. For Parts under Warranty, the Serial Number of your machine is required.

PARTS DIAGRAM

20-108H 8" JOINTER CUTTERHEAD

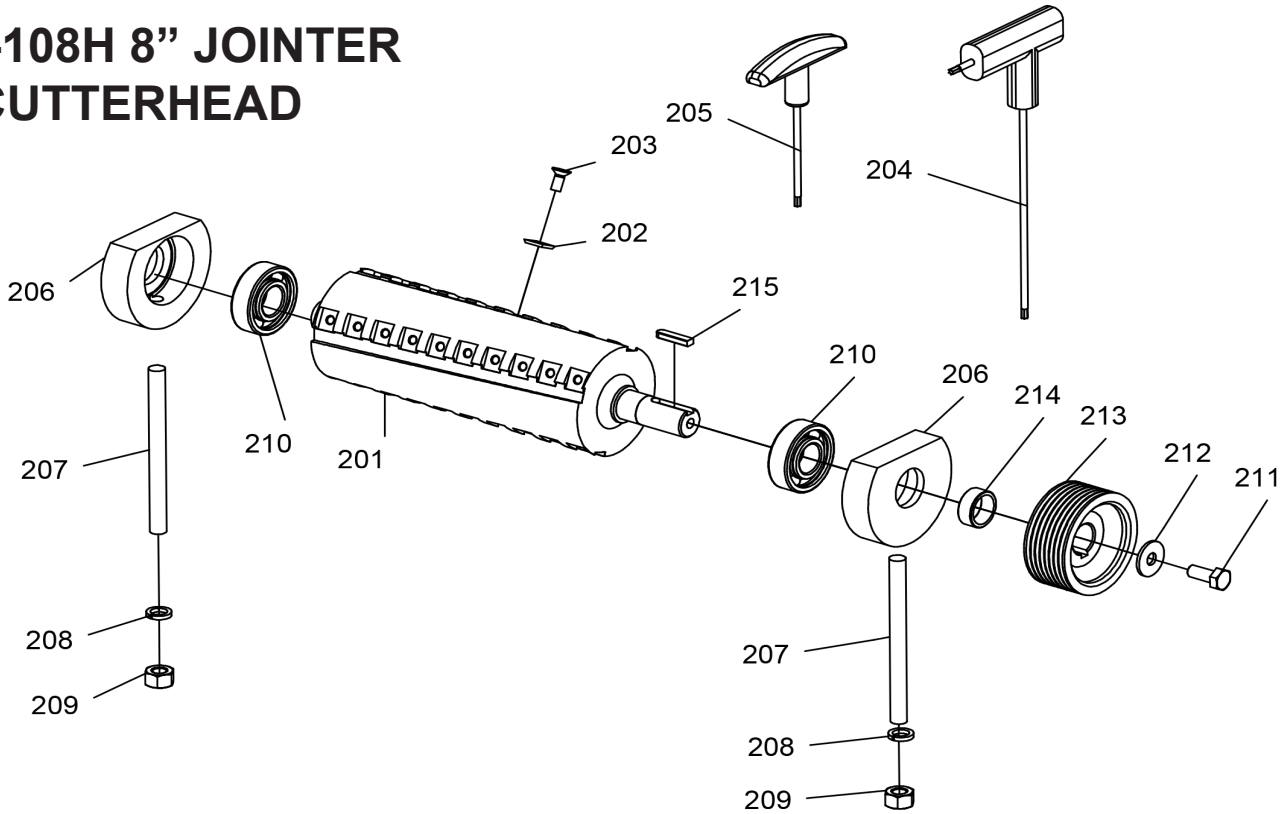

PARTS LIST

KEY NO.	DESCRIPTION	QTY.	PART NO.
201	CUTTER HEAD	1	P20-108H-201
202	INDEXABLE INSERT	40	P20-108H-202
203	FLAT CAP SCREW M5x12	40	P20-108H-203
204	L-WRENCH TORX	1	P20-108H-204
205	DRIVER BIT TORX	1	P20-108H-205
206	BEARING BLOCK	2	P20-108H-206
207	STUD	2	P20-108H-207
208	LOCK WASHER 10MM	2	P20-108H-208
209	HEX NUT M10	2	P20-108H-209
210	BALL BEARING 6204	2	P20-108H-210
211	HEX BOLT M8x20	1	P20-108H-211
212	FLAT WASHER M8x28	1	P20-108H-212
213	CUTTER HEAD PULLEY	1	P20-108H-213
214	COLLAR	1	P20-108H-214
215	KEY M6x25	1	P20-108H-215

NOTE: Please reference the Manufacturer's Part Number when calling for Replacement Parts. For Parts under Warranty, the Serial Number of your machine is required.

PARTS DIAGRAM

20-108H 8" JOINTER FENCE

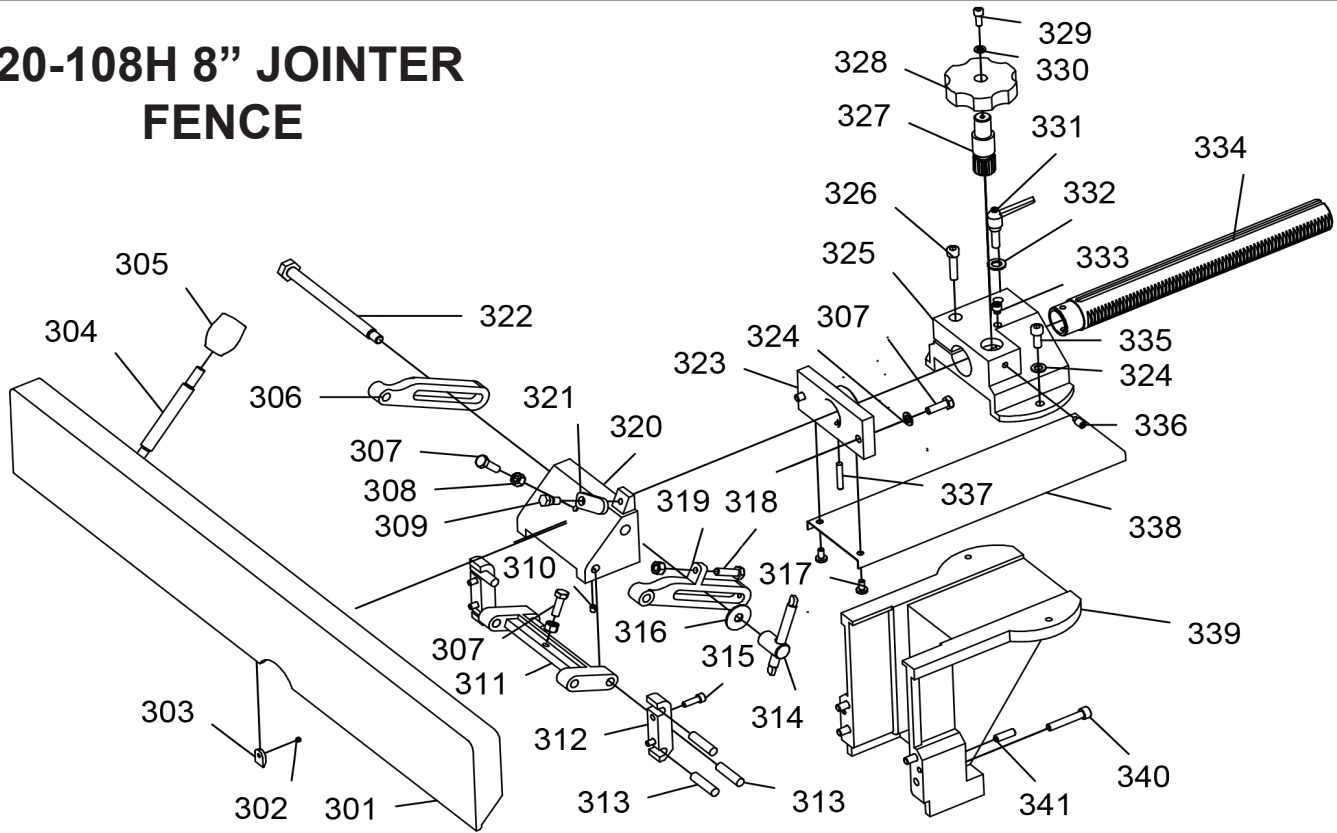

PARTS LIST

KEY NO.	DESCRIPTION	QTY.	PART NO.	KEY NO.	DESCRIPTION	QTY.	PART NO.
301	FENCE	1	P20-108H-301	322	LOCK SHAFT	1	P20-108H-322
302	SET SCREW M5x4	2	P20-108H-302	323	FENCE RAM SUPPORT	1	P20-108H-323
303	BLOCK	2	P20-108H-303	324	FLAT WASHER M8	4	P20-108H-324
304	STUD M10	1	P20-108H-304	325	FENCE RAM BRACKET	1	P20-108H-325
305	KNOB M10	1	P20-108H-305	326	CAP SCREW M8x20	1	P20-108H-326
306	FENCE TILT ARM (LEFT)	1	P20-108H-306	327	GEAR	1	P20-108H-327
307	HEX BOLT M8x25	4	P20-108H-307	328	STAR KNOB	1	P20-108H-328
308	HEX NUT M8	3	P20-108H-308	329	CAP SCREW M6x16	1	P20-108H-329
309	SHOULDER BOLT	1	P20-108H-309	330	FLAT WASHER M6	1	P20-108H-330
310	SET SCREW M6x8	2	P20-108H-310	331	LOCK LEVER M10x50	1	P20-108H-331
311	FENCE TILT SUPPORT	1	P20-108H-311	332	FLAT WASHER M10	1	P20-108H-332
312	FENCE TILT BRACKET	2	P20-108H-312	333	SET SCREW M10x16	1	P20-108H-333
313	DOWEL PIN M10x40	6	P20-108H-313	334	FENCE SLIDE BRACKET	1	P20-108H-334
314	FENCE TILT LOCK LEVER	1	P20-108H-314	335	CAP SCREW M8x20	2	P20-108H-335
315	CAP SCREW M6x20	4	P20-108H-315	336	SET SCREW M8x16	1	P20-108H-336
316	BIG WASHER	1	P20-108H-316	337	ROLL PIN M6x50	1	P20-108H-337
317	PAN HEAD SCREW M6x10	2	P20-108H-317	338	BELT GUARD	1	P20-108H-338
318	HEX BOLT M8x30	1	P20-108H-318	339	CARRIAGE MOUNT	1	P20-108H-339
319	FENCE TILT ARM (RIGHT)	1	P20-108H-319	340	CAP SCREW M8x45	4	P20-108H-340
320	FENCE ANGLE BRACKET	1	P20-108H-320	341	SET SCREW M8x25	2	P20-108H-341
321	STOP	1	P20-108H-321				

PARTS DIAGRAM

20-108H 8" JOINTER BASE

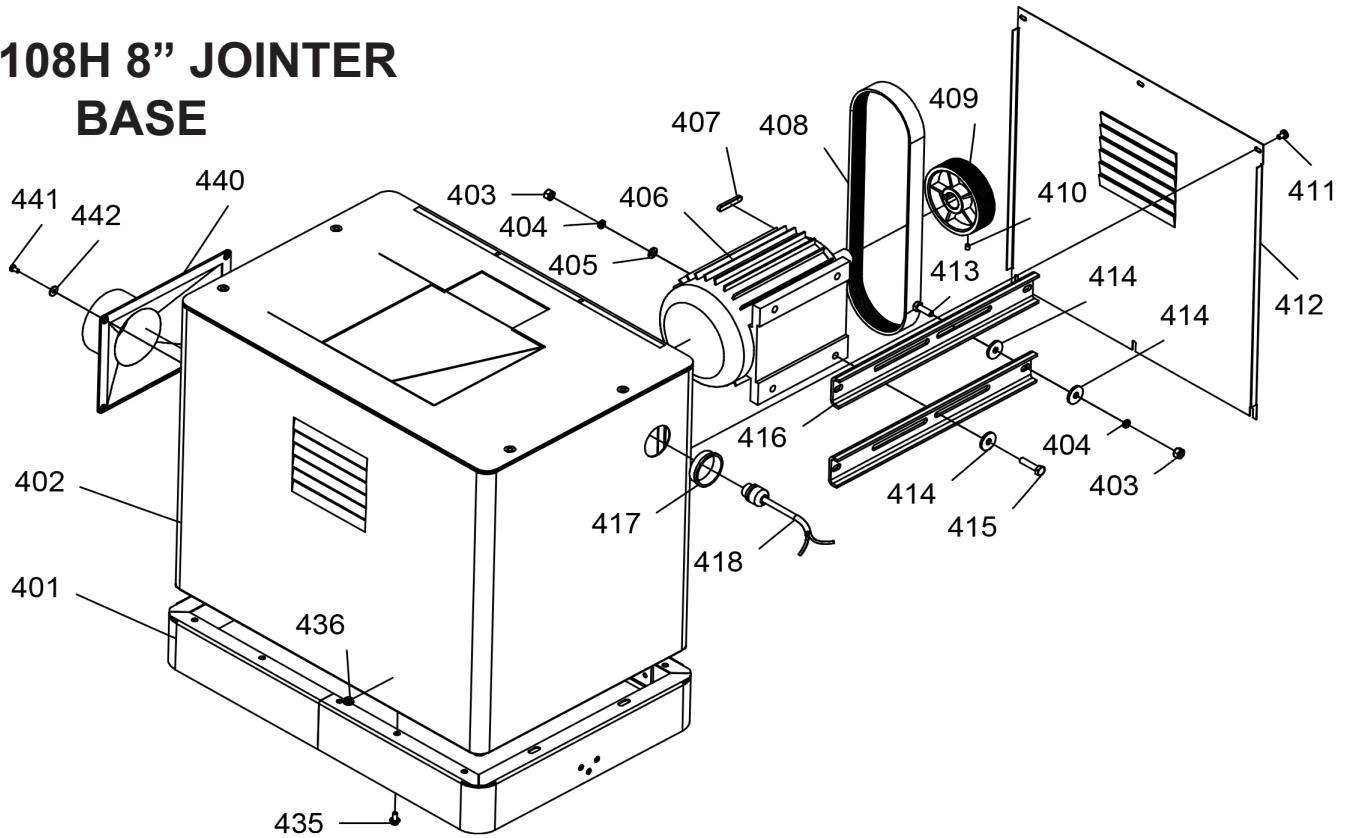

PARTS LIST

KEY NO.	DESCRIPTION	QTY.	PART NO.	KEY NO.	DESCRIPTION	QTY.	PART NO.
401	STAND BASE	1	P20-108H-401	413	HEX BOLT M8x25	4	P20-108H-413
402	STAND BODY	1	P20-108H-402	414	FENDER WASHER 8MM	12	P20-108H-414
403	HEX NUT M8	8	P20-108H-403	415	HEX BOLT M8x35	4	P20-108H-415
404	LOCK WASHER 8MM	8	P20-108H-404	416	MOTOR MOUNT PLATE	2	P20-108H-416
405	FLAT WASHER 8MM	4	P20-108H-405	417	PLASTIC GROMMET	1	P20-108H-417
406	MOTOR	1	P20-108H-406	418	MOTOR CORD	1	P20-108H-418
407	KEY 8x40	1	P20-108H-407	435	FLANGE BOLT M6x12	14	P20-108H-435
408	BELT PK1180	1	P20-108H-408	436	FLANGE NUT M6	14	P20-108H-436
409	SET SCREW M6x8	1	P20-108H-409	440	DUST PORT	1	P20-108H-440
410	MOTOR PULLEY	1	P20-108H-410	441	PAN HEAD SCREW M5x10	4	P20-108H-441
411	PAN HEAD SCREW M6x10	6	P20-108H-411	442	FENDER WASHER 5MM	4	P20-108H-442
412	BACK COVER	1	P20-108H-412				

NOTE: Please reference the Manufacturer's Part Number when calling for Replacement Parts. For Parts under Warranty, the Serial Number of your machine is required.

ACCESSORIES

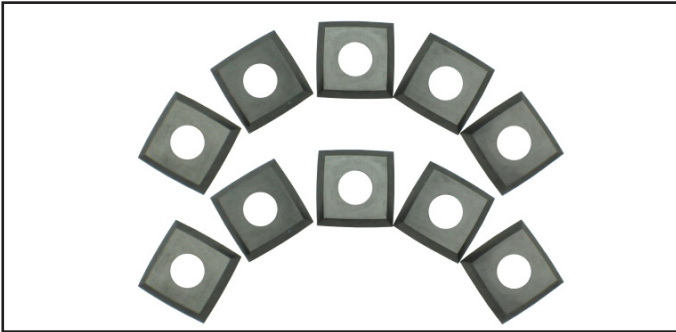

25-699 Replacement Carbide Inserts - PK 10

4-Sided, pre-sharpened carbide insert knives measure 14mm x 14mm x 2mm (0.55" x 0.55" x 0.078"). Pack of 10.

25-694 Mounting Screws for Inserts - PK 10

Special flat head, T20 Star drive screws for mounting insert cutters onto cutterheads.

23-959 Mobility Kit

Safely move your jointer around the shop with this quality optional mobility kit.

Visit www.rikontools.com to review RIKON's line of professional machinery and accessories.

WARRANTY

RIKON
POWER TOOLS

5-Year Limited Warranty

RIKON Power Tools Inc. ("Seller") warrants to only the original retail consumer/purchaser of our products that each product be free from defects in materials and workmanship for a period of five (5) years from the date the product was purchased at retail. This warranty may not be transferred.

This warranty does not apply to defects due directly or indirectly to misuse, abuse, negligence, accidents, repairs, alterations, lack of maintenance or normal wear and tear. Under no circumstances will Seller be liable for incidental or consequential damages resulting from defective products. All other warranties, expressed or implied, whether of merchantability, fitness for purpose, or otherwise are expressly disclaimed by Seller. This warranty does not cover products used for commercial, industrial or educational purposes.

This limited warranty does not apply to accessory items such as blades, drill bits, sanding discs, grinding wheels or belts and other related items.

Seller shall in no event be liable for death, injuries to persons or property, or for incidental, contingent, special, or consequential damages arising from the use of our products.

To take advantage of this warranty proof of purchase documentation, which includes date of purchase and an explanation of the complaint, must be provided.

The Seller reserves the right to effect at any time, without prior notice, those alterations to parts, fittings, and accessory equipment which they may deem necessary for any reason whatsoever.

To take advantage of this warranty, please fill out the enclosed warranty card and send it to:
RIKON Warranty, 16 Progress Rd., Billerica, MA 01821

The card must be entirely completed in order for it to be valid. If you have any questions please contact us at 877-884-5167 or warranty@rikontools.com.



**For more information:
16 Progress Road
Billerica, MA 01821**

**877-884-5167 / 978-528-5380
techsupport@rikontools.com**